

# newcomer 2023



ACCOMODA® transFORM

**NEW  
WEBSITE**

[naber.com](https://naber.com)

**Now  
online!**

**NEWCOMER  
DOWNLOAD:**



**Naber®**  
... inspires!

     
**Follow us!**



LUMICA® AstraLED SE



ARMATE® Namor



ACCOMODA® transFORM

## New highlights for unique kitchens

Unique kitchens have accessories that impress. That are visually charming, equally convincing in terms of functionality and design – and come from Naber! The **Newcomer** offers a rich selection.

The front cover shows **ACCOMODA® transFORM**, the flexible shelving and railing system with versatile storage structures. A striking eye-catcher, especially when the profile strips are backlit with LED Stripes (**LIC system compatible!**).

Also featured: the new Naber **ARMATE® Namor** faucets in full stainless steel with laminar aerator, perfectly designed, unobtrusively elegant and yet surprisingly present. Another showpiece is the extraordinary new **LUMICA® lamps**, such as the aluminium under-cabinet lamp **AstraLED SE**, which is only 5 mm thick, and the innovative multitasking lamp mounted from below, **Unika**.

When it comes to smart home components, the voice-controlled **ARMATE® E-GO Voice** faucet is hard to miss. In the interior product range **TABLON®** there are **new chairs and stools** in clear Scandinavian design with hard-wearing, sustainably sourced covers in trendy colours.

By the way: our most important newcomer is the completely redesigned **website** with the **Naber webshop** which has been optimised in all areas. Highly up-to-date, clearly laid out and packed with ideas!

Let yourself be inspired – choose your new features!



ACCOMODA® transFORM



ARMATE® E-GO Voice



LUMICA® Unika 1 colour change LED

## Contents

- NABER-CONTURA®  
Sinks
- ARMATE®  
Faucets
- SELECTAkit®  
Waste collectors
- LUMICA®  
Lighting technology
- CON-AKTIV®  
Sockets
- STOREX®  
Cabinet equipment
- ACCOMODA®  
Niche equipment
- COMPAIR®  
Ventilation technology
- MONTEC®  
Fitting materials
- TABLON®  
Interiors



### Corno Basso PR

The understated design of the all-round sink rim is continued in the integrated faucet bench of the Corno Basso PR series. Thus, each built-in sink model convinces with contemporary minimalism. Recommended combinations of sink and faucet are presented as a set offer.

The streamlined and symmetrical stainless-steel sinks are ideal for flush and surface-mounted installation. Both options ensure a harmonious transition to the worktop. The Corno Basso PR models feature the small bowl and rim radii typical of the Corno series. Thanks to the first-class workmanship of the stainless-steel material, they are extremely hard-wearing and easy to clean.



Order-No. 5011250

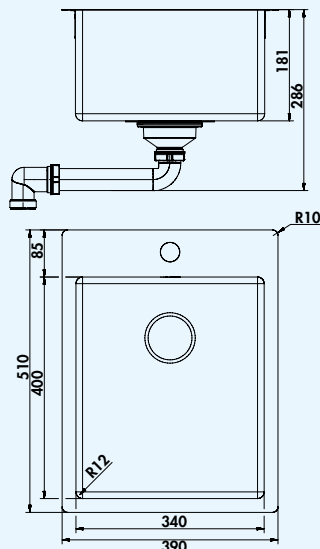

### Corno Basso PR2

Built-in sink. Single bowl. 3 1/2" drain and spill-over fitting.

**Flat edge: also suitable for flush installation**

- suitable for worktop thicknesses from 10 mm to 40 mm
- cut-out dimensions ca. 375 x 495 mm (built-in sink)

1013144 stainless steel 440.34 €

1041146 set (sink and Arco 1 faucet) 615.05 €

#### Optional accessories

1013044 Drip tray large, stainless steel 199.16 €

1013043 Drip tray small, stainless steel 178.99 €

1013045 Cutting board made of plastic, white 115.13 €

1013041 Filo dish drainer, stainless steel 63.53 €

#### Recommendations

5011250 Arco 1, chrome, high pressure 174.71 €



Order-No. 5011250

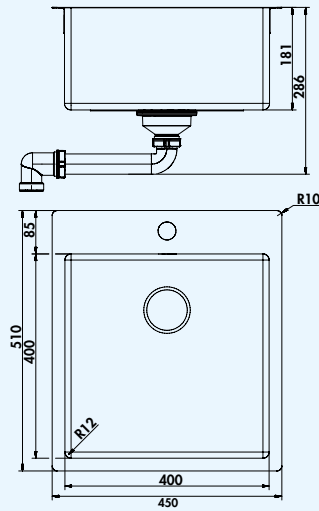

### Corno Basso PR3

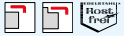

Built-in sink. Single bowl. 3 1/2" drain and spill-over fitting.  
**Flat edge: also suitable for flush installation**  
 – suitable for worktop thicknesses from 10 mm to 40 mm  
 – cut-out dimensions ca. 435 x 495 mm (built-in sink)

|         |                              |          |
|---------|------------------------------|----------|
| 1013145 | stainless steel              | 478.99 € |
| 1041147 | set (sink and Arco 1 faucet) | 626.72 € |

#### Optional accessories

|         |                                      |          |
|---------|--------------------------------------|----------|
| 1013044 | Drip tray large, stainless steel     | 199.16 € |
| 1013043 | Drip tray small, stainless steel     | 178.99 € |
| 1013045 | Cutting board made of plastic, white | 115.13 € |
| 1013041 | Filo dish drainer, stainless steel   | 63.53 €  |

#### Recommendations

|         |                               |          |
|---------|-------------------------------|----------|
| 5011250 | Arco 1, chrome, high pressure | 174.71 € |
|---------|-------------------------------|----------|



## Namor

**NEW!**

The high-quality stainless steel Namor series of faucets stands for three contemporary design concepts and guarantees maximum user benefits in all shapes and forms. Whether stylishly linear, self-confidently L-shaped or elegantly C-shaped – Namor kitchen faucets convince with their aesthetic perfection and technical precision. In every design, the Namor faucets impress with their slender lever and their stainless steel and matt black colours. Each design includes two versions: the faucet with swivelling outlet and the faucet with swivelling and pull-out hose with shower head.

With a five-year manufacturer's guarantee, we provide comprehensive customer service in Germany and Austria.

**Stainless steel**

**5 years manufacturer's warranty (except on wearing parts)**

**Factory customer service department in Germany and Austria**

**Expected to be available from January 2024.**

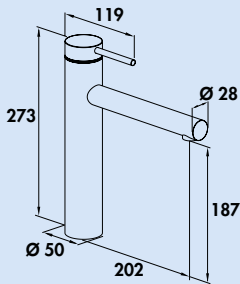

## Namor 1



Single lever faucet. With swivelling outlet, laminar aerator and ceramic cartridge.  
– swivel range 120°  
– drill Ø 35 mm

|         |                                |          |
|---------|--------------------------------|----------|
| 5025001 | stainless steel, high pressure | 284.87 € |
| 5025002 | black matt, high pressure      | 327.73 € |

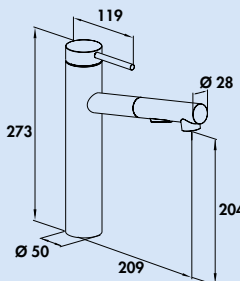

## Namor 2



Single lever mixer. With **swivelling/pull-out** hose with shower head (can be switched to stream or shower), laminar aerator and ceramic cartridge.

- swivel range 120°
- drill Ø 35 mm
- showerhead hose: simple click attachment

|         |                                |          |
|---------|--------------------------------|----------|
| 5025003 | stainless steel, high pressure | 388.24 € |
| 5025004 | black matt, high pressure      | 444.54 € |

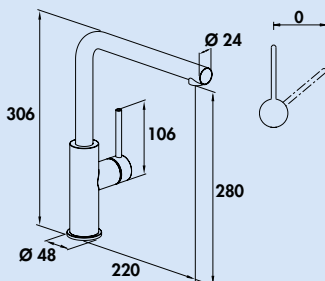

## Namor 3



Single lever faucet. With swivelling outlet, side lever, laminar aerator and ceramic cartridge.

- swivel range 120°
- drill Ø 35 mm

|         |                                |          |
|---------|--------------------------------|----------|
| 5025005 | stainless steel, high pressure | 259.66 € |
| 5025006 | black matt, high pressure      | 298.32 € |

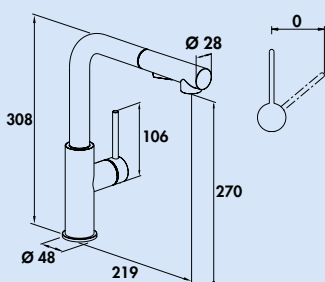

## Namor 4



Single lever mixer. With **swivelling/pull-out** hose with shower head (can be switched to stream or shower), side lever, laminar aerator and ceramic cartridge.

- swivel range 120°
- drill Ø 35 mm
- shower hose: simple click fastening

|         |                                |          |
|---------|--------------------------------|----------|
| 5025007 | stainless steel, high pressure | 344.54 € |
| 5025008 | black matt, high pressure      | 396.64 € |

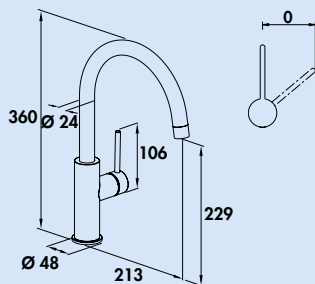

### Namor 5



Single lever mixer. With swivelling outlet, side lever, laminar aerator and ceramic cartridge.

- swivel range 120°
- drill Ø 35 mm

|                                               |                 |
|-----------------------------------------------|-----------------|
| <b>5025009</b> stainless steel, high pressure | <b>259.66 €</b> |
| <b>5025010</b> black matt, high pressure      | <b>298.32 €</b> |

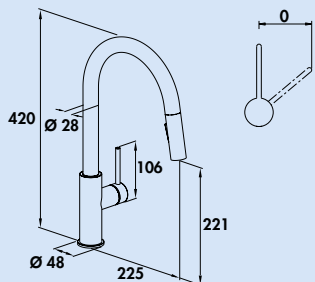

### Namor 6



Single lever mixer. With **swivelling/pull-out** hose with shower head (can be switched to stream or shower), side lever, laminar aerator and ceramic cartridge.

- swivel range 120°
- drill Ø 35 mm
- shower hose: simple click fastening

|                                               |                 |
|-----------------------------------------------|-----------------|
| <b>5025011</b> stainless steel, high pressure | <b>344.54 €</b> |
| <b>5025012</b> black matt, high pressure      | <b>396.64 €</b> |



## Drive

Drive as a character trait. The Drive faucets have a foible for their day's work. They wait sublimely for their next task and convince, seemingly effortlessly, through harmony and elegance.

The Drive 1, 1S, 2 and 5 in high pressure include **scald protection**, which allows a maximum temperature to be set at the cartridge.

**5 years manufacturer's warranty (except on wearing parts)**

**Your entitlement to customer service within the warranty period is arranged individually in consultation with us.**

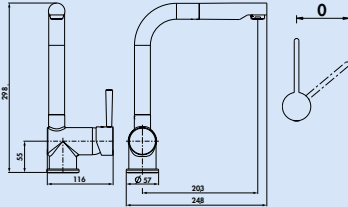

## Drive 2



Single lever faucet. With **swivelling/pull-out** outlet, side lever and ceramic cartridge.

- **scald protection** (maximum temperature to be set at the cartridge)
- swivel range 360°
- drill Ø 35 mm

|                                                        |                 |
|--------------------------------------------------------|-----------------|
| <b>5011064</b> chrome, high pressure                   | <b>193.28 €</b> |
| <b>5011087</b> chrome, low pressure                    | <b>215.13 €</b> |
| <b>5011065</b> stainless steel coloured, high pressure | <b>221.85 €</b> |
| <b>5011088</b> stainless steel coloured, low pressure  | <b>242.86 €</b> |
| <b>5011096</b> black matt, high pressure <b>NEW!</b>   | <b>223.53 €</b> |





**E-GO Voice**

**NEW!**

Smart functions at the sink for extra hygiene: besides mechanical and digital operation, E-GO Voice also offers touch-free voice control. For this user convenience, the elegant kitchen faucet has to be connected to the household Wi-Fi network. The programmable voice commands are stored as routines in Google Home or Amazon Alexa. Using the intuitive S-FLOW app, you can select rinse programmes, set the flow rate per minute or set up a child lock. The pull-out dish shower with two spray types provides freedom of movement at the sink. Including water-saving function. Available in chrome or matt black.

**5 years manufacturer's warranty (except on wearing parts)**

**Works customer service**



Expected to be available from March 2024.

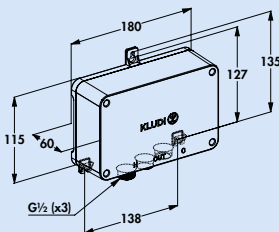
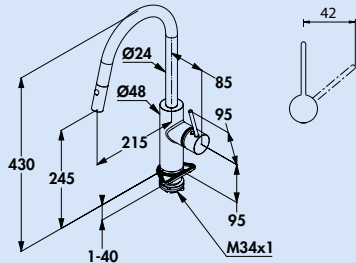

**E-GO Voice**



Single lever mixer. With **swivelling/pull-out** hose with shower head (can be switched to stream or shower), and electronic cartridge with **hot water limiter** (can be set via app). Incl. voice control and mechanical operation.

- can be operated either by voice control (connected via Wi-Fi to Amazon Alexa/Google Home), S-FLOW APP or manually
- voice control: programmable commands for touch-free operation
- two individually preset water quantities can be selected using the digital lever
- the S-FLOW APP includes a possible child safety lock and also provides information about water and energy consumption
- swivel range 360°
- drill Ø 35 mm
- incl. DO-IT connection hoses
- incl. CLICK-IT hose weight

**5023140** chrome, with plug, high pressure **1668.07 €**

**5023141** black matt, with plug, high pressure **2092.44 €**



**Cox® Base Q+**

**NEW!** Quooker®

The Cox®-Base-Q+ system is ideally suited for mounting a Cox® Base 360 S together with the Quooker CUBE, PRO3, COMBI and COMBI+. The perfectly coordinated modules provide for the space-saving arrangement of all the necessary components in a sink base unit in a **600 mm wide** sink base unit.

The fitting is carried out in just a few steps, and it is possible to respond to the given installation situation with maximum flexibility. In the rear area there is sufficient space for water connections as well as hose and cable routing. **In addition, the reservoirs can be positioned on the left or on the right of the Cox® Base.**

A holder to accommodate the cube filter can be ordered as an option.

| Container fitting system/litres |     |
|---------------------------------|-----|
| Cabinet body                    | 600 |
|                                 |     |
|                                 |     |

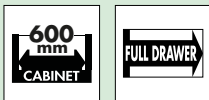
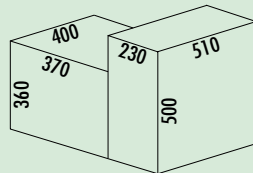

**Cox® Base Q+ 360 S/370-1**

Quooker®

For positioning in a sink base unit with a width of 600 mm.

- simple, quick and flexible installation
- positioning of the reservoirs on the left or on the right of the Cox® Base possible
- sturdy construction for mounting on the cabinet side wall, front panel and on the underside
- integrated hose and cable management
- simple replacement of the CO<sub>2</sub> cylinder
- Quooker system can be set up and connected **in front of the cabinet. The extension hoses required for this are listed below as accessories and can be ordered directly from Quooker.**
- waste volume 22 litres
- waste system with soft retraction and damping

8013378 anthracite, H 360 mm 499.16 €

**Optional accessories**

1051017 Space-saving connector, white 5.63 €

8013367 Holder for CUBE filter, anthracite 68.07 €

VERLKALT supply line extension for the PRO3, 700 mm

VERLEQ60 extension of the boiling water hose to the tap, 600 mm

VERLCUBE extension of the supply line CUBE, 1500 mm

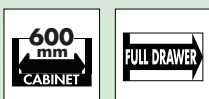
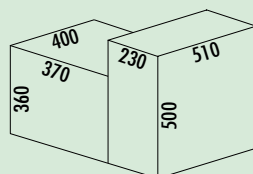

**Cox® Base Q+ 360 S/370-2**

Quooker®

For positioning in a sink base unit with a width of 600 mm.

- simple, quick and flexible installation
- positioning of the reservoirs on the left or on the right of the Cox® Base possible
- sturdy construction for mounting on the cabinet side wall, front panel and on the underside
- integrated hose and cable management
- simple replacement of the CO<sub>2</sub> cylinder
- Quooker system can be set up and connected **in front of the cabinet. The extension hoses required for this are listed below as accessories and can be ordered directly from Quooker.**
- waste volume 20(2 X 10) litres
- waste system with soft retraction and damping

8013379 anthracite, H 360 mm 499.16 €

**Optional accessories**

8013312 Bio-lid, anthracite, for 4/ 6/ 7/ 10/ 12.5 liters 14.79 €

1051017 Space-saving connector, white 5.63 €

8013367 Holder for CUBE filter, anthracite 68.07 €

VERLKALT supply line extension for the PRO3, 700 mm

VERLEQ60 extension of the boiling water hose o the tap, 600 mm

VERLCUBE extension of the supply line CUBE, 1500 mm

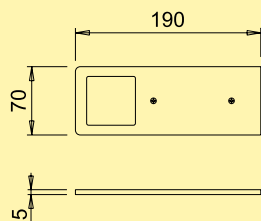

### AstraLED SE aluminium coloured



Lamp for mounting from below. Aluminium housing, 5 mm, illumination without visible LED points with integrated touch switch.

**Individual lamp without or with LED Touch switch and dimmer (w. LED Touch s. d.)**

- 5 watt, 24 V, two colour ranges: **3000 K** warm white, **3900 K** neutral white
- 65 lumen/watt
- brightness continuously dimmable using LED touch switch and dimmer
- 150 mm supply line, 2000 mm connecting line with mini-plug-in system
- additional memory function: the last setting is saved

**Set 2, 3, 5 with LED Touch switch and dimmer consisting of:**

- 1, 2 or 4 individual lamps with switch (7063314/7063343)
- 1 individual lamp with LED Touch switch and dimmer (7063315/7063344)
- 1 LED converter 2430 (7062250)
- may be extended to 6 lamps

**This product contains a light source with the energy efficiency class F.**

|                                                                         |                 |
|-------------------------------------------------------------------------|-----------------|
| <b>7063314</b> individual lamp without switch, <b>3000 K</b> warm white | <b>48.32 €</b>  |
| <b>7063315</b> single lamp w. LED Touch s. d., <b>3000 K</b> warm white | <b>99.16 €</b>  |
| <b>7063316</b> set-2, <b>3000 K</b> warm white                          | <b>169.75 €</b> |
| <b>7063317</b> set-3, <b>3000 K</b> warm white                          | <b>210.08 €</b> |
| <b>7063319</b> set-5, <b>3000 K</b> warm white                          | <b>305.04 €</b> |

|                                                                            |                 |
|----------------------------------------------------------------------------|-----------------|
| <b>7063343</b> individual lamp without switch, <b>3900 K</b> neutral white | <b>48.32 €</b>  |
| <b>7063344</b> single lamp w. LED Touch s. d., <b>3900 K</b> neutral white | <b>99.16 €</b>  |
| <b>7063345</b> set-2, <b>3900 K</b> neutral white                          | <b>169.75 €</b> |
| <b>7063346</b> set-3, <b>3900 K</b> neutral white                          | <b>210.08 €</b> |
| <b>7063347</b> set-5, <b>3900 K</b> neutral white                          | <b>305.04 €</b> |

#### Optional accessories

|                                                         |               |
|---------------------------------------------------------|---------------|
| <b>7062252</b> LED connection line 24, white, L 2000 mm | <b>4.71 €</b> |
|---------------------------------------------------------|---------------|

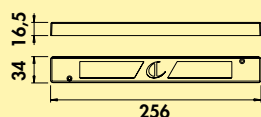

### LED converter 2430



- 30 watts, 24 VDC
- with 9-fold distributor
- 2000 mm mains connecting line
- connecting values of the individual lamps are to be observed (watt)

|                      |                |
|----------------------|----------------|
| <b>7062250</b> white | <b>61.43 €</b> |
|----------------------|----------------|

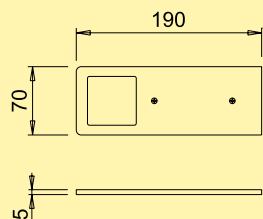

### AstraLED SE black matt



Lamp for mounting from below. Aluminium housing, 5 mm, illumination without visible LED points with integrated touch switch.

**Individual lamp without or with LED Touch switch and dimmer (w. LED Touch s. d.)**

- 5 watt, 24 V, two colour ranges: **3000 K** warm white, **3900 K** neutral white
- 65 lumen/watt
- brightness continuously dimmable using LED touch switch and dimmer
- 150 mm supply line, 2000 mm connecting line with mini-plug-in system
- additional memory function: the last setting is saved

**Set 2, 3, 5 with LED Touch switch and dimmer consisting of:**

- 1, 2 or 4 individual lamps with switch (7063333/7063348)
- 1 individual lamp with LED Touch switch and dimmer (7063334/7063349)
- 1 LED converter 2430 (7062250)
- may be extended to 6 lamps

**This product contains a light source with the energy efficiency class F.**

|                                                                         |                 |
|-------------------------------------------------------------------------|-----------------|
| <b>7063333</b> single lamp without switch, <b>3000 K</b> warm white     | <b>58.82 €</b>  |
| <b>7063334</b> single lamp w. LED Touch s. d., <b>3000 K</b> warm white | <b>109.24 €</b> |
| <b>7063335</b> set-2, <b>3000 K</b> warm white                          | <b>181.51 €</b> |
| <b>7063336</b> set-3, <b>3000 K</b> warm white                          | <b>227.31 €</b> |
| <b>7063337</b> set-5, <b>3000 K</b> warm white                          | <b>333.61 €</b> |

|                                                                            |                 |
|----------------------------------------------------------------------------|-----------------|
| <b>7063348</b> individual lamp without switch, <b>3900 K</b> neutral white | <b>58.82 €</b>  |
| <b>7063349</b> single lamp w. LED Touch s. d., <b>3900 K</b> neutral white | <b>109.24 €</b> |
| <b>7063350</b> set-2, <b>3900 K</b> neutral white                          | <b>181.51 €</b> |
| <b>7063351</b> set-3, <b>3900 K</b> neutral white                          | <b>227.31 €</b> |
| <b>7063352</b> set-5, <b>3900 K</b> neutral white                          | <b>333.61 €</b> |

#### Optional accessories

|                                                         |               |
|---------------------------------------------------------|---------------|
| <b>7062252</b> LED connection line 24, white, L 2000 mm | <b>4.71 €</b> |
|---------------------------------------------------------|---------------|

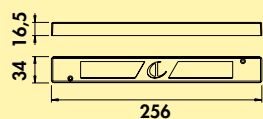

### LED converter 2430



- 30 watts, 24 VDC
- with 9-fold distributor
- 2000 mm mains connecting line
- connecting values of the individual lamps are to be observed (watt)

|                      |                |
|----------------------|----------------|
| <b>7062250</b> white | <b>61.43 €</b> |
|----------------------|----------------|

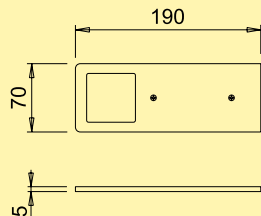

### AstraLED SE white



Lamp for mounting from below. Aluminium housing, 5 mm, illumination without visible LED points with integrated touch switch.

- Individual lamp without or with LED Touch switch and dimmer (w. LED Touch s. d.)**
- 5 watt, 24 V, two colour ranges: **3000 K** warm white, **3900 K** neutral white
  - 65 lumen/watt
  - brightness continuously dimmable using LED touch switch and dimmer
  - 150 mm supply line, 2000 mm connecting line with mini-plug-in system
  - additional memory function: the last setting is saved

**Set 2, 3, 5 with LED Touch switch and dimmer consisting of:**

- 1, 2 or 4 individual lamps with switch (7063338/7063353)
- 1 individual lamp with LED Touch switch and dimmer (7063339/7063354)
- 1 LED converter 2430 (7062250)
- may be extended to 6 lamps

**This product contains a light source with the energy efficiency class F.**

|                                                                         |                 |
|-------------------------------------------------------------------------|-----------------|
| <b>7063338</b> individual lamp without switch, <b>3000 K</b> warm white | <b>58.82 €</b>  |
| <b>7063339</b> single lamp w. LED Touch s. d., <b>3000 K</b> warm white | <b>109.24 €</b> |
| <b>7063340</b> set-2, <b>3000 K</b> warm white                          | <b>181.51 €</b> |
| <b>7063341</b> set-3, <b>3000 K</b> warm white                          | <b>227.31 €</b> |
| <b>7063342</b> set-5, <b>3000 K</b> warm white                          | <b>333.61 €</b> |

|                                                                            |                 |
|----------------------------------------------------------------------------|-----------------|
| <b>7063353</b> individual lamp without switch, <b>3900 K</b> neutral white | <b>58.82 €</b>  |
| <b>7063354</b> single lamp w. LED Touch s. d., <b>3900 K</b> neutral white | <b>109.24 €</b> |
| <b>7063355</b> set-2, <b>3900 K</b> neutral white                          | <b>181.51 €</b> |
| <b>7063356</b> set-3, <b>3900 K</b> neutral white                          | <b>227.31 €</b> |
| <b>7063357</b> set-5, <b>3900 K</b> neutral white                          | <b>333.61 €</b> |

**Optional accessories**

|                                                         |               |
|---------------------------------------------------------|---------------|
| <b>7062252</b> LED connection line 24, white, L 2000 mm | <b>4.71 €</b> |
|---------------------------------------------------------|---------------|

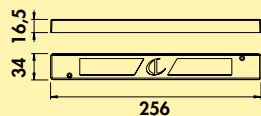

### LED converter 2430



- 30 watts, 24 VDC
- with 9-fold distributor
- 2000 mm mains connecting line
- connecting values of the individual lamps are to be observed (watt)

|                      |                |
|----------------------|----------------|
| <b>7062250</b> white | <b>61.43 €</b> |
|----------------------|----------------|

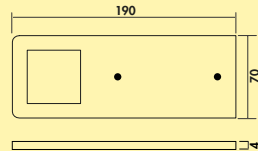

### AstraLED



Lamp for mounting from below. Aluminium housing, 4 mm.

#### Individual lamp without switch

- 5 watt, 24 V, 3100 K warm white
- 75 lumen/watt
- brightness continuously dimmable using LED touch switch and dimmer
- 2000 mm supply line, 2000 mm connecting line with mini-plug-in system
- additional memory function: the last setting is saved

#### Set 4 with LED touch switch and dimmer consisting of:

- 4 individual lamps with switch (7063304)
- 1 LED touch switch and dimmer (7062189)
- 1 LED converter 2430 (7062250)
- may be extended to 6 lamps

**This product contains a light source with the energy efficiency class F.**

**7063304** individual lamp without switch, aluminium **55.46 €**

**7063300** set-4, aluminium **248.74 €**

#### Optional accessories

**7062252** LED connection line 24, white, L 2000 mm **4.71 €**

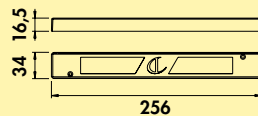

### LED converter 2430



- 30 watts, 24 VDC
- with 9-fold distributor
- 2000 mm mains connecting line
- connecting values of the individual lamps are to be observed (watt)

**7062250** white **61.43 €**

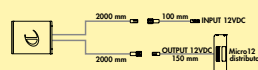

### LED Touch switch



- with 10-fold distributor
- 2000 mm supply line
- 2000 mm connection line
- suitable for 12 V and 24 VDC
- dimmer function: brightness continuously dimmable

**7062189** silver coloured **42.44 €**

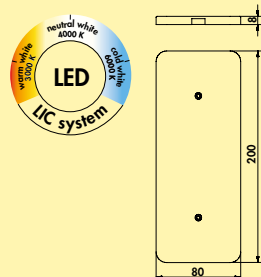

Expected to be available from November 2023.

### Pure colour change LED



Lamp mounted from below. Plastic housing, translucent white. Illumination without visible LED points. When switched off, the entire body of the lamp is made of translucent plastic, glossy white.

#### Individual lamp without switch

- housing can be screwed through with white cover caps
- 3,8 watts, 12 V
- continuous control of the light colour from **2700 K** warm white to **6500 K** cold white
- memory function: the last setting is stored
- dimmer function: brightness continuously dimmable
- max. 80 lumen/watt at **6500 K** cold white
- sockets for mini plug system in the lamp housing
- 1800 supply line with mini plug-in system

Design by **STUDIO MORITZ PUTZIER, Cologne.**

This product contains a light source of energy efficiency class **G**.

The matching colour change function converters and remote controls can be found in catalogue 1 page 276–278/23 EN.

**7063372** white 61.34 €

#### Optional accessories

**7061049** LED connection line, white, L 1800 mm 4.03 €

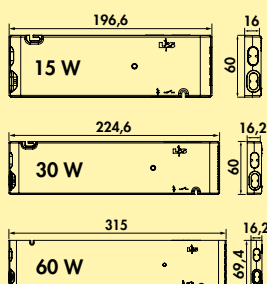
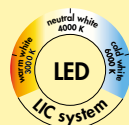

### FW function converter



The FW function converter for colour change lighting systems.

- white
- 12 VDC
- max. 36 watt load per slot on the converter
- 2000 mm mains connection line
- **switchable by Bluetooth app (module 3) or by optionally available radio remote control**

**7061286** module 2 (radio), 15 W, 4-way distributor 95.21 €

**7061271** module 2 (radio), 30 W, 6-way distributor 121.26 €

**7061273** module 2 (radio), 60 W, 6-way distributor 152.69 €

**7061287** module 3 (Bluetooth + radio), 15 W, 4-way distributor 127.56 €

**7061281** module 3 (Bluetooth + radio), 30 W, 6-way distributor 156.30 €

**7061283** module 3 (Bluetooth + radio), 60 W, 6-way distributor 188.66 €

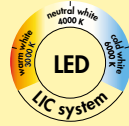

### 1-channel colour change remote control



- stepless control of the light colour
- dimming function
- auto memory: brightness and light temperature settings are saved
- one controller can be used for various colour change converters
- 8 x 90 x 50 mm (H x L x B)

7061285 white

53.61 €



**NEW!**

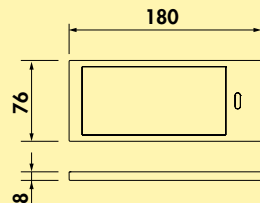

### K-Pad LED



Lamp for mounting from below. Plastic housing, illumination without visible LED spots.

#### Individual lamp without switch or with LED touch switch and dimmer

- 5 watt, 24 V, 3100 K warm white
- 55 lumen/watt
- 2000 mm supply line

#### Set-4 with LED touch switch and dimmer consisting of:

- 3 individual lamps with switch (7063303)
- 1 individual lamp with LED touch switch and dimmer (7063302)
- 1 LED converter 2430 (7062250)
- may be extended to 6 lamps

**This product contains a light source with the energy efficiency class F.**

7063303 individual lamp without switch, stainless steel coloured 66.39 €

7063302 individual lamp w. LED Touch S. D., stainless steel coloured 115.13 €

7063301 set-4, stainless steel coloured 325.21 €

#### Optional accessories

7062252 LED connection line 24, white, L 2000 mm 4.71 €

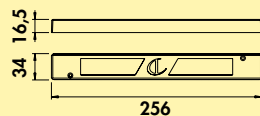

### LED converter 2430



- 30 watts, 24 VDC
- with 9-fold distributor
- 2000 mm mains connecting line
- connecting values of the individual lamps are to be observed (watt)

7062250 white

61.43 €



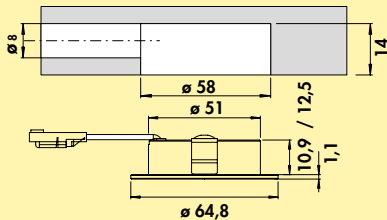

**Anelli LED stainless steel coloured**



Built-in lamp. Aluminium body, illumination without visible LED points.

**Individual lamp without switch**

- 4 watts, 12 V, two colour areas: **4000 K** neutral white, **3000 K** warm white
- 62 lumen/watt
- 2000 mm supply line
- drill Ø 58 mm

**Set 2, 3, 5 without switch consisting of:**

- 2, 3 or 5 individual lamps without switch (7061324/7063358)
- 1 LED converter 20 (7062309)
- may be extended to 5 lamps

**This product contains a light source of energy efficiency class F.**

You will find suitable switches in catalogue 1 page 407–408/23 EN.

|                                                                        |                 |
|------------------------------------------------------------------------|-----------------|
| <b>7061324</b> single lamp without switch, <b>4000 K</b> neutral white | <b>31.76 €</b>  |
| <b>7061326</b> set 2, <b>4000 K</b> neutral white                      | <b>91.60 €</b>  |
| <b>7061328</b> set 3, <b>4000 K</b> neutral white                      | <b>127.56 €</b> |
| <b>7061330</b> set 5, <b>4000 K</b> neutral white                      | <b>193.11 €</b> |

|                                                                                 |                 |
|---------------------------------------------------------------------------------|-----------------|
| <b>7063358</b> single lamp without switch, <b>3000 K</b> warm white <b>NEW!</b> | <b>31.76 €</b>  |
| <b>7063360</b> set 2, <b>3000 K</b> warm white <b>NEW!</b>                      | <b>91.60 €</b>  |
| <b>7063362</b> set 3, <b>3000 K</b> warm white <b>NEW!</b>                      | <b>127.56 €</b> |
| <b>7063364</b> set 5, <b>3000 K</b> warm white <b>NEW!</b>                      | <b>193.11 €</b> |

**Optional accessories**

|                                                                      |               |
|----------------------------------------------------------------------|---------------|
| <b>7061049</b> LED connection line, white, L 1800 mm                 | <b>4.03 €</b> |
| <b>7061322</b> Anelli mounting ring, stainless steel coloured, 15 mm | <b>4.12 €</b> |

Expected to be available from November 2023.

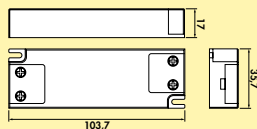

**LED converter 20**



- 20 watts, 12 VDC
- with 6-fold distributor
- 2000 mm mains connecting line
- connecting values of the individual lamps are to be observed (watt)

|                     |                |
|---------------------|----------------|
| <b>7062309</b> grey | <b>46.30 €</b> |
|---------------------|----------------|

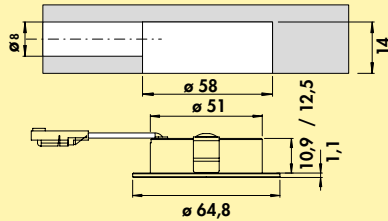

### Anelli LED black matt



Built-in lamp. Aluminium body, illumination without visible LED points.

#### Individual lamp without switch

- 4 watts, 12 V, two colour areas: **4000 K** neutral white, **3000 K** warm white
- 62 lumen/watt
- 2000 mm supply line
- drill Ø 58 mm

#### Set 2, 3, 5 without switch consisting of:

- 2, 3 or 5 individual lamps without switch (7061325/7063359)
- 1 LED converter 20 (7062309)
- may be extended to 5 lamps

**This product contains a light source of energy efficiency class F.**

You will find suitable switches in catalogue 1 page 407–408/23 EN.

|         |                                                         |          |
|---------|---------------------------------------------------------|----------|
| 7061325 | single lamp without switch, <b>4000 K</b> neutral white | 31.76 €  |
| 7061327 | set 2, <b>4000 K</b> neutral white                      | 91.60 €  |
| 7061329 | set 3, <b>4000 K</b> neutral white                      | 127.56 € |
| 7061331 | set 5, <b>4000 K</b> neutral white                      | 193.11 € |

|         |                                                                  |          |
|---------|------------------------------------------------------------------|----------|
| 7063359 | single lamp without switch, <b>3000 K</b> warm white <b>NEW!</b> | 31.76 €  |
| 7063361 | set 2, <b>3000 K</b> warm white <b>NEW!</b>                      | 91.60 €  |
| 7063363 | set 3, <b>3000 K</b> warm white <b>NEW!</b>                      | 127.56 € |
| 7063365 | set 5, <b>3000 K</b> warm white <b>NEW!</b>                      | 193.11 € |

#### Optional accessories

|         |                                         |        |
|---------|-----------------------------------------|--------|
| 7061049 | LED connection line, white, L 1800 mm   | 4.03 € |
| 7061323 | Anelli mounting ring, matt black, 15 mm | 4.12 € |

Expected to be available from November 2023.

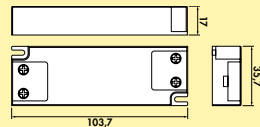

### LED converter 20



- 20 watts, 12 VDC
- with 6-fold distributor
- 2000 mm mains connecting line
- connecting values of the individual lamps are to be observed (watt)

|         |      |         |
|---------|------|---------|
| 7062309 | grey | 46.30 € |
|---------|------|---------|

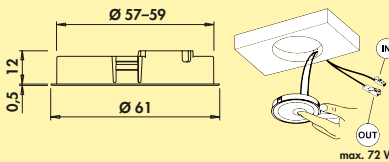
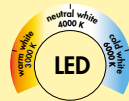

### Kronos colour change LED



Lumière encastrable. Boîtier en plastique, rond, éclairage sans points LED visibles avec interrupteur tactile intégré.

#### Individual lamp without switch or with LED Touch switch and dimmer (w. LED Touch s. d.)

- 2,8 watts, 24 V
- control of the light colour from 2700 K warm white to 3900 K cold white
- memory function: the last setting is stored
- dimmer function: brightness continuously dimmable
- max. 80 lumen/watt
- 2000 mm supply line
- drill Ø 57–59 mm, installation depth 12 mm
- connection to LED converter 2430 (7062250)

**This product contains a light source of energy efficiency class E.**

**7063367** single lamp w. LED Touch s. d., black matt **100.84 €**

**7063366** individual lamp without switch, black matt **47.06 €**

#### Optional accessories

**7062252** LED connection line 24, white, L 2000 mm **4.71 €**

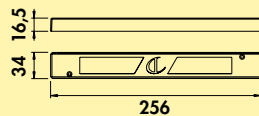

### LED converter 2430



- 30 watts, 24 VDC
- with 9-fold distributor
- 2000 mm mains connecting line
- connecting values of the individual lamps are to be observed (watt)

**7062250** white **61.43 €**

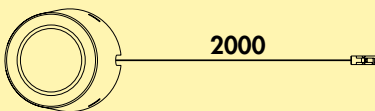
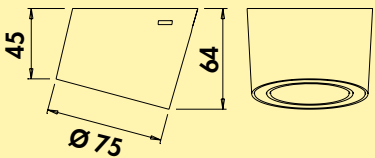

### Unika 1 colour change LED



Surface mounted lamp. Plastic body, round, Illumination without visible LED points.

- 4,5 watts, 24 V
- control of the light colour from **2700 K** warm white to **3900 K** neutral white (only in combination with Unika 2 LED Touch switch and dimmer 7063369)
- memory function: the last setting is stored
- dimmer function: brightness continuously dimmable
- max. 80 lumen/watt
- 2000 mm supply line
- connection to LED converter 2430 (7062250)

**This product contains a light source with the energy efficiency class E.**

**7063368** individual lamp without switch, black matt **65.55 €**

#### Optional accessories

**7062252** LED connection line 24, white, L 2000 mm **4.71 €**

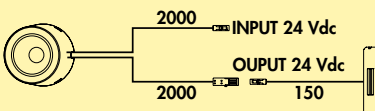
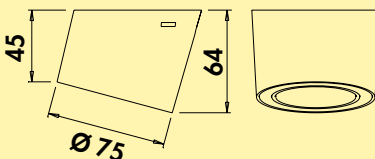

### Unika 2 colour change LED



Surface mounted lamp. Plastic body, round, Illumination without visible LED points with **integrated** touch switch.

#### Individual lamp with LED Touch switch and dimmer (w. LED Touch s. d.)

- 4,5 watts, 24 V
- control of the light colour from **2700 K** warm white to **3900 K** cold white
- memory function: the last setting is stored
- dimmer function: brightness continuously dimmable
- max. 80 lumen/watt
- 2000 mm supply line
- connection to LED converter 2430 (7062250)

**This product contains a light source with the energy efficiency class E.**

**7063369** single lamp w. LED Touch s. d., black matt **126.05 €**

#### Optional accessories

**7062252** LED connection line 24, white, L 2000 mm **4.71 €**

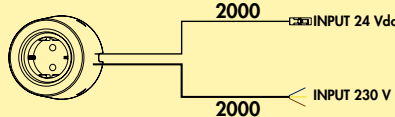
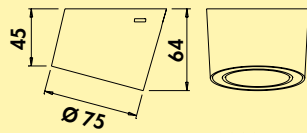
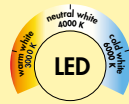

### Unika 3 colour change LED



Surface mounted lamp. Plastic body, round, illumination without visible LED points with **integrated** socket.

- 4,5 watts, 24 V
- control of the light colour from **2700 K** warm white to **3900 K** neutral white (only in combination with Unika 2 LED Touch switch and dimmer 7063369)
- memory function: the last setting is stored
- dimmer function: brightness continuously dimmable
- max. 80 lumen/watt
- socket 240 V/16 A
- 2000 mm supply line
- connection to LED converter 2430 (7062250)

**This product contains a light source with the energy efficiency class E.**

**7063370** single lamp with earthed plug sockets, black matt **101.68 €**

#### Optional accessories

**7062252** LED connection line 24, white, L 2000 mm **4.71 €**

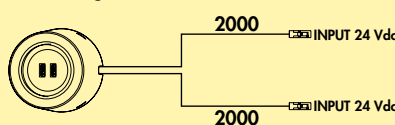
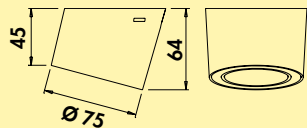
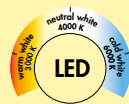

### Unika 4 colour change LED



Surface mounted lamp. Plastic body, round, illumination without visible LED points with integrated double USB charger.

- lamp 4,5 watts, 24 V
- USB 20 watts, 24 V
- control of the light colour from **2700 K** warm white to **3900 K** neutral white (only in combination with Unika 2 LED Touch switch and dimmer 7063369)
- memory function: the last setting is stored
- dimmer function: brightness continuously dimmable
- max. 80 lumen/watt
- 2 x USB charger type A, 5 VDC, IA/I out: 2 x 1050 mA
- 2000 mm supply line
- connection to LED converter 2430 (7062250)

**This product contains a light source with the energy efficiency class E.**

**7063371** luminaire individuel avec 2-fold USB A, black matt **111.76 €**

#### Optional accessories

**7062252** LED connection line 24, white, L 2000 mm **4.71 €**

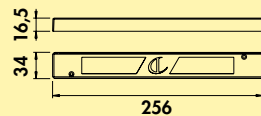

### LED converter 2430



- 30 watts, 24 VDC
- with 9-fold distributor
- 2000 mm mains connecting line
- connecting values of the individual lamps are to be observed (watt)

**7062250** white **61.43 €**

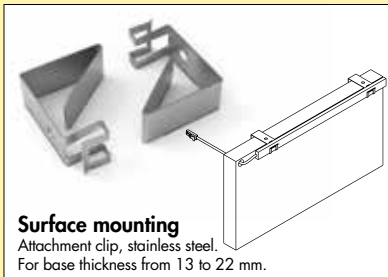
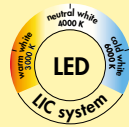

**Surface mounting**

Attachment clip, stainless steel.  
For base thickness from 13 to 22 mm.

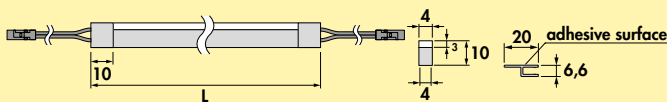

**Calamaro LED Flex Stripes colour change**    

Flexible LED strips. Ambient light. LED cast in silicone. Easy installation directly on the base with 3 self-adhesive profile brackets of 900 mm each.

**Flex Stripes**

- 7.2 watts per meter, 12 VDC
- continuous control of the light colour from **3000 K** warm white to **6000 K** cold white
- max. 45 lumen/watt at **6000 K** cold white
- strips 4 x 10 mm wide, may be shortened every 25 mm, no connection after the cutting point
- incl. 3 x self-adhesive plastic profile supports, 900 mm each
- 2000 mm two-sided supply line
- LIC LED system compatible

**This product contains a light source of energy efficiency class G.**

**Note: We recommend 4 fastening clips (7061258) per meter!**

The matching colour change function converters and remote controls can be found in catalogue 1 page 276–278/23 EN.

**7061246** L 2600 mm, white **157.23 €**

**Optional accessories**

**7061049** LED connection line, white, L 1800 mm **4.03 €**

**7061258** Fixing clips, stainless steel, price per PU of 2 pieces **NEW!** **9.08 €**

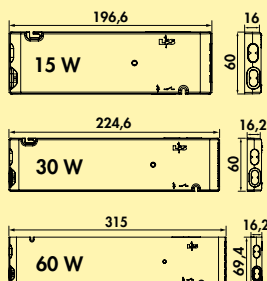
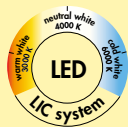

### FW function converter



The FW function converter for colour change lighting systems.

- white
- 12 VDC
- max. 36 watt load per slot on the converter
- 2000 mm mains connection line
- **switchable by Bluetooth app (module 3) or by optionally available radio remote control**

|                |                                                       |                 |
|----------------|-------------------------------------------------------|-----------------|
| <b>7061286</b> | module 2 (radio), 15 W, 4-way distributor             | <b>95.21 €</b>  |
| <b>7061271</b> | module 2 (radio), 30 W, 6-way distributor             | <b>121.26 €</b> |
| <b>7061273</b> | module 2 (radio), 60 W, 6-way distributor             | <b>152.69 €</b> |
| <b>7061287</b> | module 3 (Bluetooth + radio), 15 W, 4-way distributor | <b>127.56 €</b> |
| <b>7061281</b> | module 3 (Bluetooth + radio), 30 W, 6-way distributor | <b>156.30 €</b> |
| <b>7061283</b> | module 3 (Bluetooth + radio), 60 W, 6-way distributor | <b>188.66 €</b> |

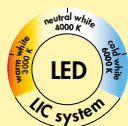

### 1-channel colour change remote control



- stepless control of the light colour
- dimming function
- auto memory: brightness and light temperature settings are saved
- one controller can be used for various colour change converters
- 8 x 90 x 50 mm (H x L x B)

|                |       |                |
|----------------|-------|----------------|
| <b>7061285</b> | white | <b>53.61 €</b> |
|----------------|-------|----------------|

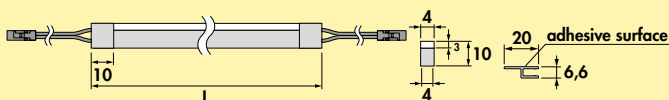
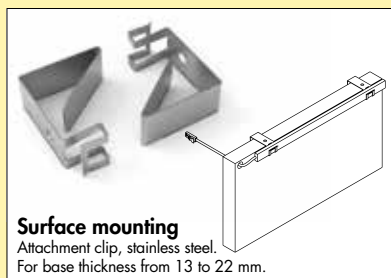

### Calamaro LED Flex Stripes incl. base profile

Flexible LED strips. Ambient light. LED cast in silicone. Easy installation directly on the base with 3 self-adhesive profile brackets of 900 mm each.

#### Flex Stripes

- 7.2 watts per meter, 12 VDC
- max. 45 lumen/watt
- strips 4 x 10 mm wide, may be shortened every 25 mm, no connection after the cutting point
- incl. 3 x self-adhesive plastic profile supports, 900 mm each
- 2000 mm two-sided supply line
- the light colour can be changed from **3000 K** warm white to **4000 K** neutral white using the supplied adapter cable

**This product contains a light source of energy efficiency class F.**

**Note: We recommend 4 fastening clips (7061258) per meter!**

**7061257** L 2600 mm, white **138.32 €**

#### Optional accessories

**7061049** LED connection line, white, L 1800 mm **4.03 €**

**7061258** Fixing clips, stainless steel, price per PU of 2 pieces **NEW!** **9.08 €**

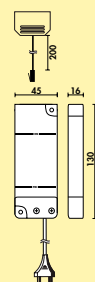

### LED converter 12

- 15 watts, 12 VDC
- with 6-fold distributor
- 2000 mm mains connection line
- connection values of the individual lamps are to be observed (watt)

**7061025** grey **44.45 €**



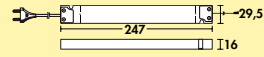

**LED converter 30**



- 30 watts, 12 VDC
- with 6-fold distributor
- 2000 mm mains connection line
- connection values of the individual lamps are to be observed (watt)

**7061026** grey

**64.29 €**

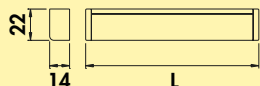
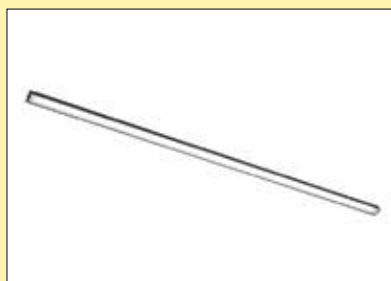

### Lungo LED black matt



Lamp mounted from below. Slender aluminium profile with glare-free cover.

#### Individual lamp with LED Touch switch and dimmer

- 24 V, 4000 K neutral white
- 85 lumen/watt
- 2000 mm supply line
- ready for connection to LED converter 2430 (7062250)
- cable outlet rear below side

**This product contains a light source of energy efficiency class G.**

|                                          |                 |
|------------------------------------------|-----------------|
| <b>7062411</b> L 450 mm, 6.2 W, 3000 K   | <b>82.27 €</b>  |
| <b>7062412</b> L 600 mm, 8.2 W, 4000 K   | <b>88.66 €</b>  |
| <b>7062413</b> L 900 mm, 12.5 W, 4000 K  | <b>108.32 €</b> |
| <b>7062414</b> L 1200 mm, 16.8 W, 4000 K | <b>128.49 €</b> |

#### Optional accessories

|                                                         |               |
|---------------------------------------------------------|---------------|
| <b>7062252</b> LED connection line 24, white, L 2000 mm | <b>4.71 €</b> |
|---------------------------------------------------------|---------------|

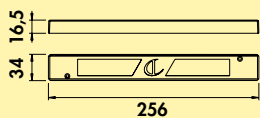

### LED converter 2430



- 30 watts, 24 VDC
- with 9-fold distributor
- 2000 mm mains connecting line
- connecting values of the individual lamps are to be observed (watt)

|                      |                |
|----------------------|----------------|
| <b>7062250</b> white | <b>61.43 €</b> |
|----------------------|----------------|

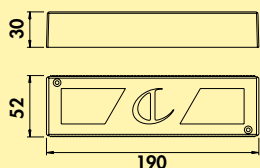

### LED converter 2460



- 60 watts, 24 VDC
- with 9-fold distributor
- 2000 mm mains connecting line
- connecting values of the individual lamps are to be observed (watt)

|                      |                |
|----------------------|----------------|
| <b>7062251</b> white | <b>79.50 €</b> |
|----------------------|----------------|

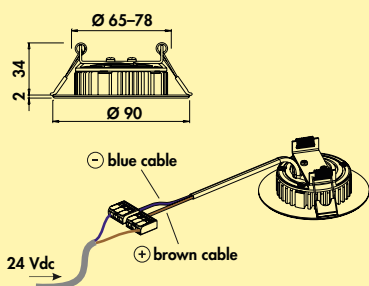

### EXO LED



Built-in lamp, ceiling lamp. Light fixture made of diecast aluminium, white, powerful COB light source, central beam optics.

#### Individual lamp without switch

- 4.4 watt, 24 V, 3000 K warm white
- dimming function: brightness continuously dimmable (only in combination with 7063375)
- max. 105 lumen/watt
- IP20
- with spring clips for installation in cavity ceilings
- supply line 2000 mm
- cable length secondary 150 mm supply line
- drill-Ø 65–78 mm
- installation depth 34 mm
- connection to LED converter 2430 (7062250)

**This product contains a light source with the energy efficiency class E.**

7063374 single lamp without switch

73.95 €

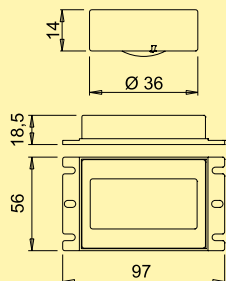

### Call-Me switch



- receiver and remote control
- 24 V, 72 watt
- with 9-fold distributor
- memory function: the last setting is stored
- dimming function
- 150 mm/500 mm supply line

7063375 black

125.21 €

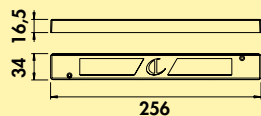

### LED converter 2430



- 30 watts, 24 VDC
- with 9-fold distributor
- 2000 mm mains connecting line
- connecting values of the individual lamps are to be observed (watt)

7062250 white

61.43 €

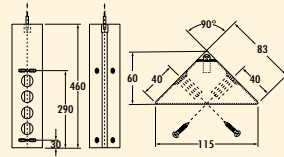

### Mira ES1 USB A/C

**NEW!** CE

- Corner socket element. 4-fold. With telescopic intermediate piece without end caps.
- 240 V/16 A
  - 460–580 x 83 x 83 mm (H x W x D)
  - 1 x USB charger type A, 5 VDC, out: 1000 mA
  - 1 x USB charger type C, 5 VDC, out: 1000 mA
  - 2000 mm mains connection line, earthing contact plug enclosed loosely
  - cable outlet back top

|                                |                 |
|--------------------------------|-----------------|
| <b>7053239</b> stainless steel | <b>195.63 €</b> |
| <b>7053240</b> black matt      | <b>199.83 €</b> |

Expected to be available from November 2023.

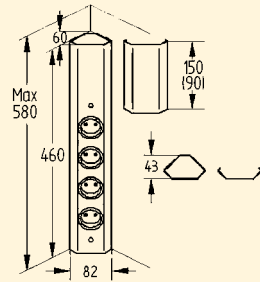

### Mira corner small USB A/C

**NEW!** CE

- Socket element. 4-fold.
- housing in a compact design with telescopic intermediate piece
  - 240 V/16 A
  - 460–580 x 59 x 59 mm (H x W x D)
  - 1 x USB charger type A, 5 VDC, out: 1000 mA
  - 1 x USB charger type C, 5 VDC, out: 1000 mA
  - 2000 mm mains connection line, earthing contact plug enclosed loosely
  - cable outlet back top

|                                |                 |
|--------------------------------|-----------------|
| <b>7053241</b> stainless steel | <b>190.34 €</b> |
| <b>7053242</b> black matt      | <b>194.54 €</b> |

Expected to be available from November 2023.

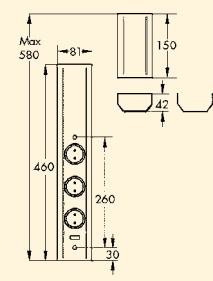

### Mira wall small USB A/C

**NEW!** CE

- Socket element. 3-fold.
- stainless steel housing in a compact design with telescopic intermediate piece
  - 240 V/16 A
  - 1 x USB charger type A, 5 VDC, IA/ I out: 1000 mA
  - 1 x USB charger type C, 5 VDC, IA/ I out: 1000 mA
  - 460–580 x 81 x 42 mm (H x W x D)
  - 2000 mm mains connection line, earthed plug supplied loose
  - cable outlet back top

|                                |                 |
|--------------------------------|-----------------|
| <b>7053243</b> stainless steel | <b>188.66 €</b> |
| <b>7053244</b> black matt      | <b>192.02 €</b> |

Expected to be available from November 2023.

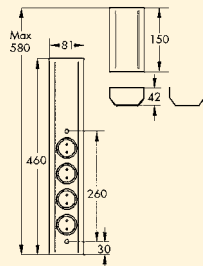

### Mira wall small



Socket element. 4-fold.

- stainless steel housing in a compact design with telescopic intermediate piece
- 240 V/16 A
- 460–580 x 81 x 42 mm (H x W x D)
- 2000 mm mains connection line, earthing contact plug enclosed loosely
- cable outlet back top

Expected to be available from November 2023.

7053090 stainless steel

125.21 €

7053245 black matt **NEW!**

134.03 €

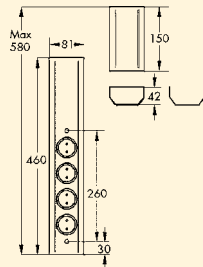

### Mira wall small S



Socket element. 3-fold and switch for external lighting.

- stainless steel housing in a compact design with telescopic intermediate piece
- 240 V/16 A
- 460–580 x 81 x 42 mm (H x W x D)
- 2000 mm mains connection line, earthed plug supplied loose
- 1800 mm switch cable with Euro coupling
- cable outlet back top

Expected to be available from November 2023.

7053092 stainless steel

134.45 €

7053246 black matt **NEW!**

153.78 €



### Evoline® Dock Cuisine

Power supply as a design object, wherever you need it.

Easy installation.

Convenient, affordable and easy to clean.

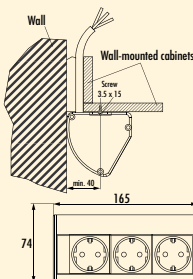

### Evoline® Dock



Socket element. 3-fold. Especially suited for installation below wall-mounted cabinets or under shelves.

- 2 x fastening elements enclosed loosely
- 74 x 165 x 75 mm (H x W x D)
- 2500 mm mains connection line, earthing contact plug enclosed loosely
- cable outlet back (below/top)

8031133 stainless steel coloured

101.51 €

8031113 black matt **NEW!**

90.76 €

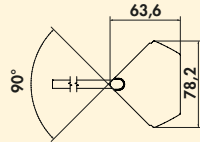
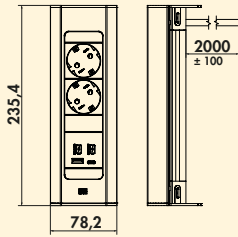

### Casia 2K power strip USB A+C

**NEW!** CE

Corner socket element, aluminium. 2-fold. Suitable for vertical and horizontal mounting.

- 240 V/16 A
- 1 x USB charger type A, 5 VDC, IA/I out: 1100 mA
- 1 x USB charger type C, 5 VDC, IA/I out: 1100 mA
- 235 x 78 x 64 mm (H x W x D)
- 2000 mm mains connection line, earthing contact plug enclosed loosely
- cable outlet back

**7053247** stainless steel coloured **240.34 €**

**7053248** black matt **240.34 €**

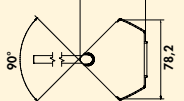
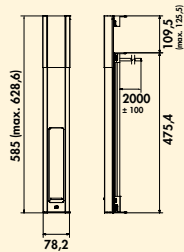

### Casia 2L power strip USB A+C

**NEW!** CE

Corner socket element, aluminium. 3-fold. Suitable for vertical and horizontal mounting. With telescopic compensation piece and coverable sockets.

- 240 V/16 A
- 1 x USB charger type A, 5 VDC, IA/I out: 1100 mA
- 1 x USB charger type C, 5 VDC, IA/I out: 1100 mA
- 475 x 78 x 64 mm (H x W x D)
- 2000 mm mains connection line, earthing contact plug enclosed loosely
- cable outlet back

**7053249** stainless steel coloured **314.29 €**

**7053250** black matt **314.29 €**



### Twist plug socket

The double socket is suitable for installation in kitchen worktops made of wood, laminate, stone or glass. Rotating the cover by 90° enables access to two earthing contact sockets that provide a convenient and stable power supply. The fixing is carried out using two mounted hexagon socket head cap screws M6 and clamping claw for or two clamping screws with hexagon socket M6. The cable can be routed downwards or sideways. 1.5 mm<sup>2</sup> black and cable end sleeves. Plastic casing with cover in nickel-plated die-cast zinc, brushed stainless steel coloured.

Since the installation depth is only 40 mm, installation above drawers is possible.

#### Please observe installation instructions!

- very low installation depth (approx. 40 mm)
- compact design (H x Ø approx. 42.5 x 115 mm)
- space-saving cable management
- simple and quick mounting
- retrofitting possible
- integrated water drainage

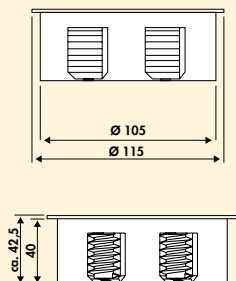

### Twist double plug socket



Socket element. 2-fold.

- 3680 watt/16 A, 250 VAC, IP20
- H05VV-F 3G1
- 3-pin with earthing contact
- 2000 mm mains connection line, earthing contact plug enclosed loosely
- drill Ø 105 mm, for board thicknesses from 8 mm
- increased contact protection
- cable outlet below side

|                |                                                       |                 |
|----------------|-------------------------------------------------------|-----------------|
| <b>7053021</b> | with earthed plug sockets, stainless steel coloured   | <b>126.05 €</b> |
| <b>7053075</b> | with earthed plug sockets, black matt                 | <b>157.98 €</b> |
| <b>7053076</b> | with earthed plug sockets, white matt                 | <b>157.98 €</b> |
| <b>7053025</b> | with Belgian/French sockets, stainless steel coloured | <b>150.42 €</b> |
| <b>7053085</b> | with Belgian/French sockets, black matt               | <b>157.14 €</b> |
| <b>7053086</b> | with Belgian/French sockets, white matt               | <b>157.14 €</b> |
| <b>7053059</b> | with Swiss sockets, stainless steel coloured          | <b>152.94 €</b> |
| <b>7053189</b> | with Swiss sockets, black matt <b>NEW!</b>            | <b>184.03 €</b> |

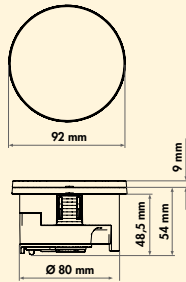

### Evoline® Circle80 Hide

**NEW!**   

Socket element. With USB charger (charging station). When closed, the element is almost flush with the worktop. By turning the lid, the socket and the USB charger are exposed.

- installation depth 48.5 mm
- rotating lid black
- double USB charger type A+C, 5 V, 2,1 A
- 2500 mm mains connection line, earthing contact plug enclosed loose
- drill Ø ca. 80 mm
- board thickness from 10 mm
- without lid, flush installation is possible
- cable outlet below

8031114 with earthed plug socket, USB A/C

154.62 €

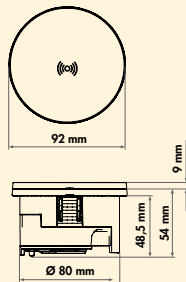

### Evoline® Circle80 DisQ

**NEW!**   

Socket element. With USB charger (charging station). When closed, the element is almost flush with the worktop. By turning the lid, the socket and the USB charger are exposed.

- Qi inductive charging station in the lid (wireless charger). Wireless charging of mobile phones based on the Qi standard with a maximum of 15 watts and magnetic function.
- external power supply plug for Qi charging function enclosed loose, for which an additional socket is required
- installation depth 48.5 mm
- rotating lid black
- double USB charger type A+C, 5 V, 2,1 A
- 2500 mm mains connection line, earthing contact plug enclosed loose
- drill Ø ca. 80 mm
- board thickness from 10 mm
- cable outlet below

8031115 with earthed plug socket, USB A/C

284.03 €



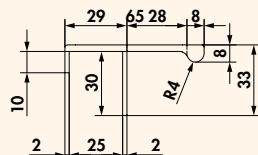

### Towel holder for handle-less kitchens

- aluminium anodised
- for handle-less kitchens, with front thickness of 16–21 mm
- no installation work, simply push-on
- felt insert supplied loose, glue in prior to fitting

**8032009** L 320 mm, stainless steel coloured **41.43 €**

**8032010** L 520 mm, stainless steel coloured **69.41 €**

**8032023** L 320 mm, black matt **NEW!** **41.43 €**

**8032013** L 520 mm, black matt **69.41 €**



**transFORM**

**NEW!**

The system transFORM with its matt black powder-coated surface is characterised by its extreme flexibility and versatility. A basic profile and a trapezoidal cover profile can be used to create slatted walls, niche systems, solitary shelves and wall shelves. Horizontally and vertically. For the kitchen and living room. The system offers additional functionality through the option of illuminating the profiles with commercially available 8 mm LED strips and, when mounted horizontally, being able to hook in various sliding functional elements.

Expected to be available from October 2023.

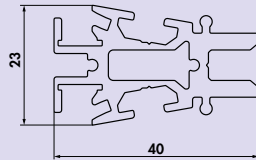

**transFORM basic profile**

Aluminium profile 23 x 40 mm, anodised. Pre-drilled by 5 mm at regular intervals. With grooves on both sides to accommodate 8 mm LED strips. When mounted horizontally, for the integration of various sliding functional elements.

|                          |                 |
|--------------------------|-----------------|
| <b>8041210</b> L 1800 mm | <b>81.09 €</b>  |
| <b>8041211</b> L 2400 mm | <b>107.48 €</b> |

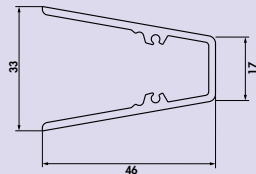

**transFORM cover profile**

Aluminium profile 16/33 x 46 mm. Trapezoidal. Can be plugged onto the base profile.

- black matt, powder-coated
- end caps and screws included

|                          |                 |
|--------------------------|-----------------|
| <b>8041212</b> L 1800 mm | <b>120.59 €</b> |
| <b>8041213</b> L 2400 mm | <b>147.06 €</b> |



**transFORM profile set**

Black matt, powder-coated.

**Set consisting of:**

- basic profile and cover profile (end caps and screws included)

|                          |                 |
|--------------------------|-----------------|
| <b>8041214</b> L 900 mm  | <b>133.61 €</b> |
| <b>8041215</b> L 1200 mm | <b>147.06 €</b> |
| <b>8041216</b> L 1500 mm | <b>167.23 €</b> |

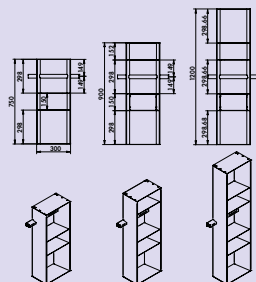

**transFORM add-on unit**

Add-on unit. Integration with the transFORM profile set.

- black matt, powder-coated
- grooves on both sides of the basic profile to accommodate 8 mm LED strips
- simple and quick installation

|                                                |                  |
|------------------------------------------------|------------------|
| <b>8041217</b> 750 x 300 x 180 mm (H x W x D)  | <b>847.90 €</b>  |
| <b>8041218</b> 900 x 300 x 180 mm (H x W x D)  | <b>1070.59 €</b> |
| <b>8041219</b> 1200 x 300 x 180 mm (H x W x D) | <b>1344.54 €</b> |

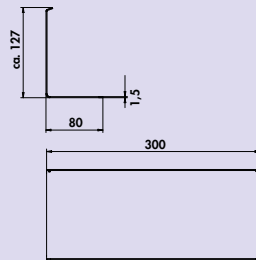

### transFORM tray 1

- L-shaped.
- powder-coated
- 120 x 300 x 80 mm (H x W x D)

8041220 black matt

56.72 €

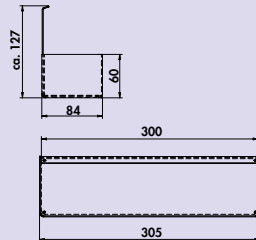

### transFORM tray 2

- With removable box.
- powder-coated
- 120 x 300 x 84 mm (H x W x D)

8041221 black matt

109.24 €

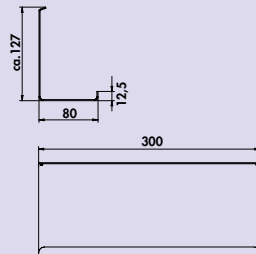

### transFORM tray 3

- For a tablet, mobile phone, cookbook, etc. With ledge for a secure stand.
- powder-coated
- 120 x 300 x 80 mm (H x W x D)

8041222 black matt

56.72 €

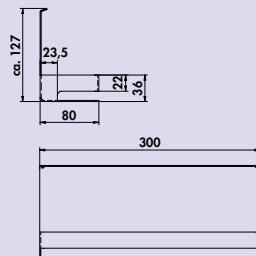

### transFORM spice rack

- With surround.
- powder-coated
- 120 x 300 x 80 mm (H x W x D)

8041223 black matt

78.99 €

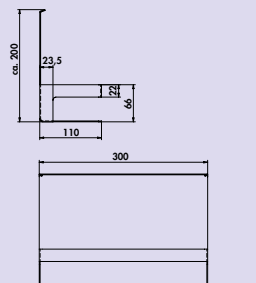

### transFORM bottle holder

- With surround.
- powder-coated
- 195 x 300 x 110 mm (H x W x D)

8041224 black matt

83.19 €

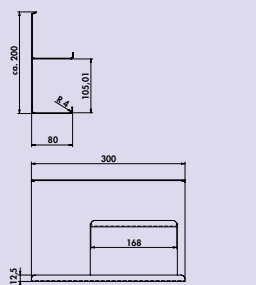

### transFORM tray 4

- Two levels. For bottles and jars.
- powder-coated
- 195 x 300 x 80 mm (H x W x D)

8041225 black matt

78.99 €

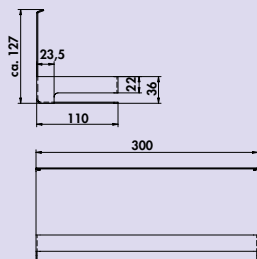

### transFORM paper roll holder

- 1-fold. For household rolls.  
 – powder-coated  
 – 120 x 300 x 110 mm (H x W x D)

8041226 black matt

78.99 €

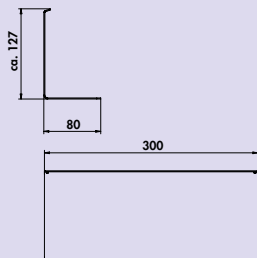

### transFORM glass holder

- For 3 glasses.  
 – powder-coated  
 – 120 x 300 x 80 mm (H x W x D)

8041227 black matt

50.84 €

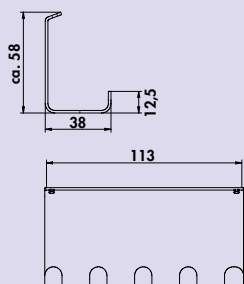

### transFORM hook strip

- 5-fold.  
 – powder-coated  
 – 40 x 115 x 40 mm (H x W x D)

8041228 black matt

35.71 €

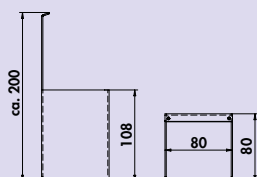

### transFORM tubular pot

- For storage of kitchen utensils.  
 – powder-coated  
 – 195 x 75 x 85 mm (H x W x D)

8041229 black matt

75.21 €

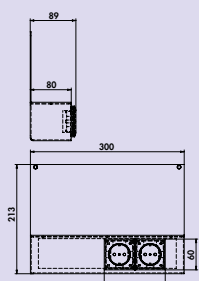

### transFORM Powerbox

With integrated double socket. Powder-coated.

- Powerbox consisting of:**  
 – 2 sockets with earthing contact  
 – 1 supply line 2000 mm  
 – 120 x 300 x 80 mm (H x W x D)

8041230 black matt

150.84 €



### transFORM shelf support

For mounting the customer's shelves. For fastening to the basic profile.  
 — locating hole for screw fastening  
 — depth 200 mm

**Shelves not included in delivery.**

|                    |         |
|--------------------|---------|
| 8041231 black matt | 86.55 € |
|--------------------|---------|

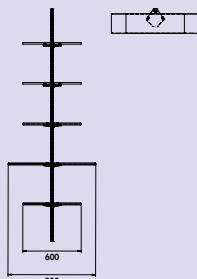

### transFORM sheet metal shelf set

Black matt, powder-coated.

**Set consisting of:**  
 — sheet metal shelf  
 — bracket set

|                              |          |
|------------------------------|----------|
| 8041232 600 x 200 mm (W x D) | 154.54 € |
| 8041233 900 x 200 mm (W x D) | 173.11 € |

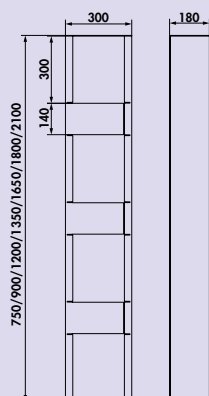

### transFORM solitary shelf unit

Shelf system. Black matt, powder-coated.

- grooves on both sides to accommodate 8 mm LED strips (not included in the scope of delivery)
- simple and quick installation

|                |                                 |                  |
|----------------|---------------------------------|------------------|
| <b>8041234</b> | 750 x 300 x 180 mm (H x W x D)  | <b>726.89 €</b>  |
| <b>8041235</b> | 900 x 300 x 180 mm (H x W x D)  | <b>957.98 €</b>  |
| <b>8041236</b> | 1200 x 300 x 180 mm (H x W x D) | <b>1235.29 €</b> |
| <b>8041237</b> | 1350 x 300 x 180 mm (H x W x D) | <b>1242.02 €</b> |
| <b>8041238</b> | 1650 x 300 x 180 mm (H x W x D) | <b>1344.54 €</b> |
| <b>8041239</b> | 1800 x 300 x 180 mm (H x W x D) | <b>1457.98 €</b> |
| <b>8041240</b> | 2100 x 300 x 180 mm (H x W x D) | <b>1861.34 €</b> |

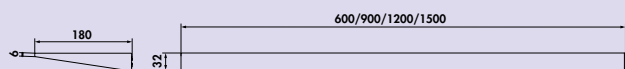

### transFORM wall shelf

Shelf system. Black matt, powder-coated.

- grooves on both sides to accommodate 8 mm LED strips (not included in the scope of delivery)
- integration of various slidable functional elements
- simple and quick installation

|                |                                |                 |
|----------------|--------------------------------|-----------------|
| <b>8041241</b> | 600 x 66 x 180 mm (H x W x D)  | <b>527.73 €</b> |
| <b>8041242</b> | 900 x 66 x 180 mm (H x W x D)  | <b>603.36 €</b> |
| <b>8041243</b> | 1200 x 66 x 180 mm (H x W x D) | <b>667.23 €</b> |
| <b>8041244</b> | 1500 x 66 x 180 mm (H x W x D) | <b>723.53 €</b> |



### Colour change LED strip

For Manubrio and Light profile colour change.

**This product contains a light source of energy efficiency class F.**

**7061300** L 2600 mm, 20.3 W/12 V **98.82 €**

#### Optional accessories

**7061049** LED connection line, white, L 1800 mm **4.03 €**

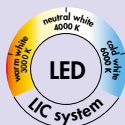

### FW function converter



The FW function converter for colour change lighting systems.

- white
- 12 VDC
- max. 36 watt load per slot on the converter
- 2000 mm mains connection line
- **switchable by Bluetooth app (module 3) or by optionally available radio remote control**

**7061286** module 2 (radio), 15 W, 4-way distributor **95.21 €**

**7061271** module 2 (radio), 30 W, 6-way distributor **121.26 €**

**7061273** module 2 (radio), 60 W, 6-way distributor **152.69 €**

**7061287** module 3 (Bluetooth + radio), 15 W, 4-way distributor **127.56 €**

**7061281** module 3 (Bluetooth + radio), 30 W, 6-way distributor **156.30 €**

**7061283** module 3 (Bluetooth + radio), 60 W, 6-way distributor **188.66 €**

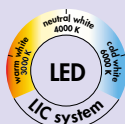
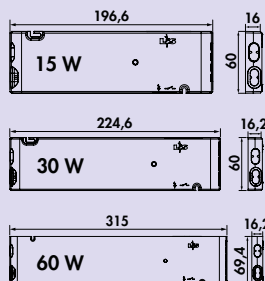

### 1-channel colour change remote control



- stepless control of the light colour
- dimming function
- auto memory: brightness and light temperature settings are saved
- one controller can be used for various colour change converters
- 8 x 90 x 50 mm (H x L x B)

**7061285** white **53.61 €**



### 230 volt connecting line



For connecting several FW function converters.

**7061284** L 300 mm, white **3.28 €**

**7061279** L 1000 mm, white **5.46 €**



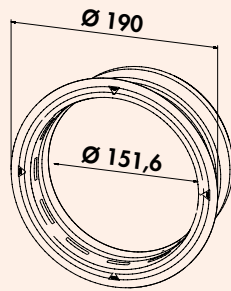

### P-K-Klima-R 150 wall conduct

**NEW!**

Wall conduct, with backflow trap

- N-Klick system for secure connection with the universal connector
- direct connection of the flat adapter, round pipe or round pipe bends
- max. wall thickness 550 mm, can be shortened to 220 mm
- core hole drilling in nominal Ø 162 or 164 mm
- wall sleeve for tool-free installation and sealing against leakage

4051068 white 62.35 €

4051070 anthracite 63.52 €

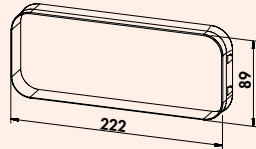

### P-K-Klima flow 150 wall conduct

**NEW!**

Wall conduct, with backflow trap

- N-Klick system for secure connection with the universal connector
- direct connection of the flat adapter, round pipe or round pipe bends
- max. wall thickness 550 mm, can be shortened to 220 mm
- core hole drilling in nominal Ø 162 or 164 mm
- wall sleeve for tool-free installation and sealing against leakage

4051069 white 71.26 €

4051071 anthracite 72.43 €



### Prime 150 base ventilation grid set flow

**NEW!**

For ducted downdraft or hob ventilation systems.

- N-Klick system for secure connection with the universal connector
- with optimised guide vanes
- improved flow technology

Set consisting of:

- 2 x P-VRO 150 flat duct pipe (4051001)
- 1 x P-RBV 150 pipe bend vertical 90° (4051008)
- 1 x P-RBV 150 pipe bend vertical 90° short (4051033)
- 5 x P-UVB 150 universal connector flat (4051004)
- 1 x Base ventilation grid flow (8033014/8033015)

4051072 stainless steel coloured 356.63 €

4051073 black matt 356.63 €

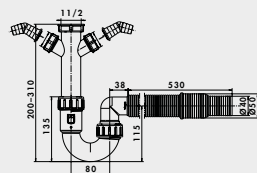

### Odour trap 2, flexible

**NEW!**

The flexible connection of this standard siphon solves almost any plumbing problem. With two appliance connections for a dishwasher or washing machine. Drain hose may be shortened.

**1051161** Connecting sleeve Ø 40/50 mm

**14.79 €**



**Backflow preventer nipple 3/4"**

**NEW!**

Backflow preventers protect drinking water pipes against the unwanted backflow of used water according to DIN EN 61770.  
 – for **white appliances according to KTW-BWGL**  
 – brass  
 – backflow preventer nipple internal thread 3/4" x 3/4" external thread to prevent backflow of water in dishwashers, washing machines and similar appliances

5031119 IG/AG 3/4"

23.11 €



**Flow meter**

**NEW!**

Measuring beaker. Plastic. For flow measurement. For measuring the water flow rate in low-pressure storage tanks.

Note: the water flow rate should not exceed **4.5–5 l/min!**

**In extreme cases, a water flow rate that is too high can cause the boiler to burst.**

6011045 red

59.92 €



### Stove connecting box WAGO clamps

**NEW!** 

For surface and flush mounting.

- 16 A/V400 V
- screwless clamping points up to 6 mm<sup>2</sup>
- for 55 mm wall box, H 12 mm
- swivelling strain relief
- double cable outlet (5 x 2 mm<sup>2</sup>, 3 x 4 mm<sup>2</sup>)
- with snap-on lid

**7012028** white

**35.21 €**

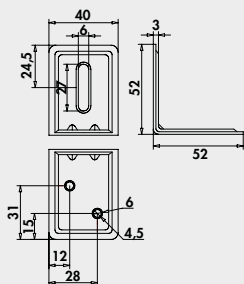

### Bracket 9

**NEW!**

- thickness 3 mm
- sides 52 x 52 mm
- with pleat

1111144 zinc-coated

2.44 €



### Top safe fitting

**NEW!**

Special safety fitting for fastening wall cabinets according to DIN EN 1153, also for bridging electrical cables.

1111145 140 x 50 x 10 mm, zinc-coated

16.72 €



3038135

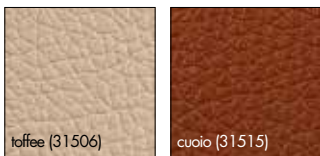
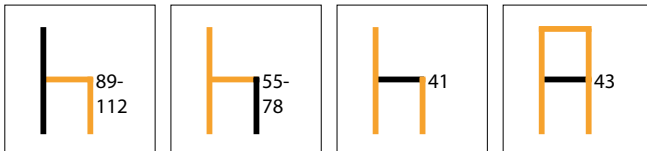

## Buono K



Stool.

- variable height adjustment
- seat and back upholstered imitation leather
- abrasion resistance > 100.000
- closed back
- max. load ca. 90 kg
- **seat height adjustable from 55 to 78 cm**

Delivery time 4–5 weeks.

Selected models available from stock.

Current delivery time information on [naber.com](http://naber.com)

|                                                                        |                 |
|------------------------------------------------------------------------|-----------------|
| <b>3038134</b> frame stainless steel, cover black (31529)              | <b>383.19 €</b> |
| <b>3038135</b> frame stainless steel, cover light mud (28004)          | <b>383.19 €</b> |
| <b>3038181</b> frame stainless steel, cover dark grey (31528)          | <b>383.19 €</b> |
| <b>3038182</b> frame stainless steel, cover cream (31507)              | <b>383.19 €</b> |
| <b>3038183</b> frame stainless steel, cover toffee (31506) <b>NEW!</b> | <b>383.19 €</b> |
| <b>3038184</b> frame stainless steel, cover cuoio (31515) <b>NEW!</b>  | <b>383.19 €</b> |

|                                                                 |                 |
|-----------------------------------------------------------------|-----------------|
| <b>3038185</b> frame black, cover black (31529) <b>NEW!</b>     | <b>383.19 €</b> |
| <b>3038186</b> frame black, cover light mud (28004) <b>NEW!</b> | <b>383.19 €</b> |
| <b>3038187</b> frame black, cover dark grey (31528) <b>NEW!</b> | <b>383.19 €</b> |
| <b>3038188</b> frame black, cover cream (31507) <b>NEW!</b>     | <b>383.19 €</b> |
| <b>3038189</b> frame black, cover toffee (31506) <b>NEW!</b>    | <b>383.19 €</b> |
| <b>3038190</b> frame black, cover cuoio (31515) <b>NEW!</b>     | <b>383.19 €</b> |

### Optional accessories

|                                                              |                |
|--------------------------------------------------------------|----------------|
| <b>1111139</b> Cleaning spray for artificial leather, 500 ml | <b>14.87 €</b> |
|--------------------------------------------------------------|----------------|



3038481

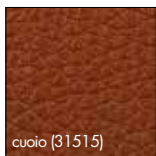
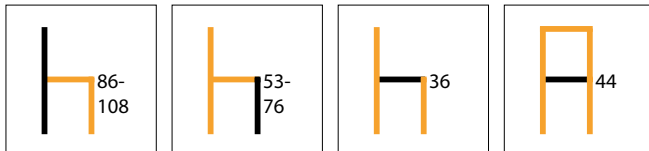

### Level K



Stool.

- variable height adjustment
- seat and back upholstered imitation leather
- abrasion resistance > 100.000
- closed back
- max. load ca. 100 kg
- **seat height adjustable from 53 to 76 cm**

**Delivery time 4–5 weeks.**

|                |                                                         |                 |
|----------------|---------------------------------------------------------|-----------------|
| <b>3038480</b> | frame stainless steel, cover black (31529)              | <b>393.28 €</b> |
| <b>3038481</b> | frame stainless steel, cover dark grey (31528)          | <b>393.28 €</b> |
| <b>3038488</b> | frame stainless steel, cover cream (31507)              | <b>393.28 €</b> |
| <b>3038489</b> | frame stainless steel, cover toffee (31506) <b>NEW!</b> | <b>393.28 €</b> |
| <b>3038490</b> | frame stainless steel, cover cuoio (31515) <b>NEW!</b>  | <b>393.28 €</b> |

|                |                                                  |                 |
|----------------|--------------------------------------------------|-----------------|
| <b>3038491</b> | frame black, cover black (31529) <b>NEW!</b>     | <b>393.28 €</b> |
| <b>3038492</b> | frame black, cover dark grey (31528) <b>NEW!</b> | <b>393.28 €</b> |
| <b>3038493</b> | frame black, cover cream (31507) <b>NEW!</b>     | <b>393.28 €</b> |
| <b>3038494</b> | frame black, cover toffee (31506) <b>NEW!</b>    | <b>393.28 €</b> |
| <b>3038495</b> | frame black, cover cuoio (31515) <b>NEW!</b>     | <b>393.28 €</b> |

#### Optional accessories

|                |                                               |                |
|----------------|-----------------------------------------------|----------------|
| <b>1111139</b> | Cleaning spray for artificial leather, 500 ml | <b>14.87 €</b> |
|----------------|-----------------------------------------------|----------------|



### Level WS



Stool.

- variable height adjustment
- seat and backrest in water/dirt repellent fabric with a fine grain structure
- abrasion resistance 35.000
- closed back
- max. load ca. 100 kg
- **seat height adjustable from 53 to 76 cm**

Delivery time 4–5 weeks.

3038483

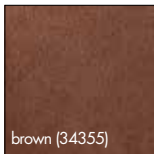
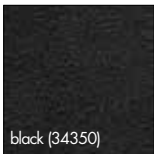
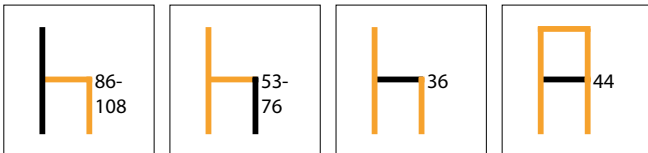

|                                                             |                 |
|-------------------------------------------------------------|-----------------|
| <b>3038482</b> frame stainless steel, cover black (34350)   | <b>394.12 €</b> |
| <b>3038483</b> frame stainless steel, cover brown (34355)   | <b>394.12 €</b> |
| <b>3038496</b> frame black, cover black (34350) <b>NEW!</b> | <b>393.28 €</b> |
| <b>3038497</b> frame black, cover brown (34355) <b>NEW!</b> | <b>393.28 €</b> |





3039064

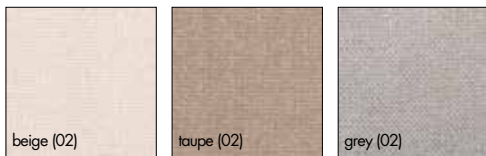
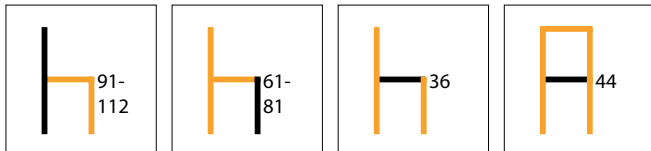

## Bella R

**NEW!**

Stool.

- variable height adjustment
- seat and backrest in 100 % recycled polyester
- abrasion resistance 50.000
- water-repellent
- closed back
- max. load ca. 120 kg
- **seat height adjustable from 61 to 81 cm**
- assembly required

**Delivery time 4–5 weeks.**

|                                                  |                 |
|--------------------------------------------------|-----------------|
| <b>3039063</b> frame black, cover beige (02)     | <b>207.56 €</b> |
| <b>3039064</b> frame black, cover taupe (02)     | <b>207.56 €</b> |
| <b>3039065</b> frame black, cover grey (02)      | <b>207.56 €</b> |
| <b>Optional accessories</b>                      |                 |
| <b>3039101</b> Care set for textiles, 2 x 500 ml | <b>57.56 €</b>  |



3039060

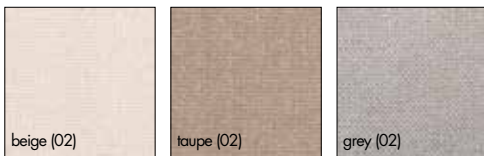
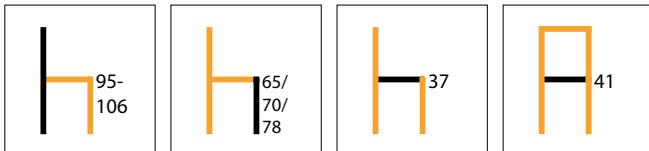

## Aron R

**NEW!**

Stool.

- height adjustment (**fixed**) possible with two included extension sets (black) to extend the frame
- seat and backrest in 100 % recycled polyester
- abrasion resistance 50.000
- water-repellent
- closed backrest
- load-bearing capacity up to approx. 160 kg
- height to top edge of armrests 54 cm
- **seat height (fixed) adjustable to 65 cm/70 cm/78 cm**
- delivered disassembled

Delivery time 4–5 weeks.

|                                                  |                 |
|--------------------------------------------------|-----------------|
| <b>3039060</b> frame black, cover beige (02)     | <b>284.03 €</b> |
| <b>3039061</b> frame black, cover taupe (02)     | <b>284.03 €</b> |
| <b>3039062</b> frame black, cover grey (02)      | <b>284.03 €</b> |
| <b>Optional accessories</b>                      |                 |
| <b>3039101</b> Care set for textiles, 2 x 500 ml | <b>57.56 €</b>  |



3039066

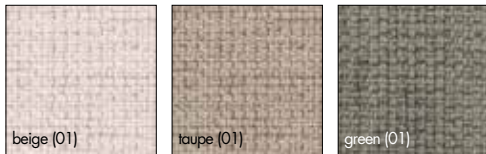
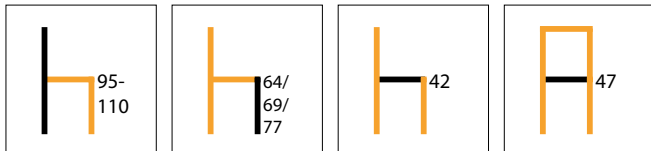

## Rocco R

**NEW!**

Stool.

- height adjustment (**fixed**) possible with two included extension sets (black) to extend the frame
- seat and backrest in 100 % recycled polyester
- abrasion resistance 50.000
- water-repellent
- open backrest
- load-bearing capacity up to approx. 160 kg
- **seat height (fixed) adjustable to 64 cm/69 cm/77 cm**
- delivered disassembled

Delivery time 4-5 weeks.

|         |                               |          |
|---------|-------------------------------|----------|
| 3039055 | frame black, cover beige (01) | 272.27 € |
| 3039056 | frame black, cover taupe (01) | 272.27 € |
| 3039066 | frame black, cover green (01) | 272.27 € |

### Optional accessories

|         |                                   |         |
|---------|-----------------------------------|---------|
| 3039101 | Care set for textiles, 2 x 500 ml | 57.56 € |
|---------|-----------------------------------|---------|



3038149

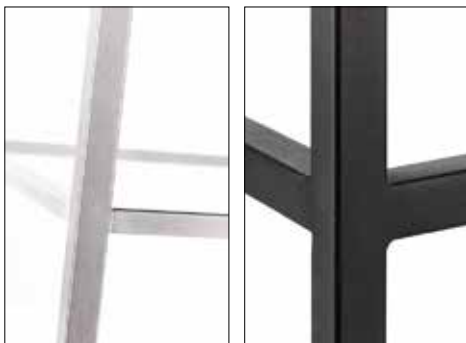
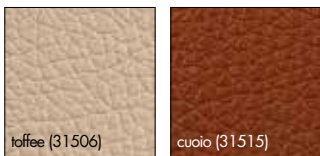
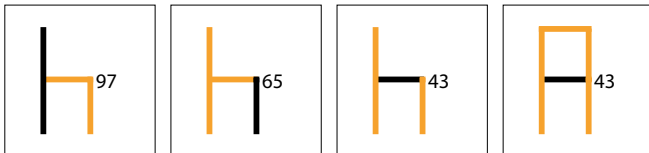

## Daimo 2K



Stool.

- seat and backrest upholstered imitation leather
- abrasion resistance > 100.000
- closed backrest
- max. load ca. 130 kg
- seat height 65 cm

Delivery time 4–5 weeks.

Selected models available from stock.

Current delivery time information on [naber.com](http://naber.com)

|         |                                                            |          |
|---------|------------------------------------------------------------|----------|
| 3038131 | frame stainless steel, cover black (31529)                 | 289.92 € |
| 3038132 | frame stainless steel, cover light mud (28004)             | 289.92 € |
| 3038147 | frame stainless steel, cover dark grey (31528) <b>NEW!</b> | 289.92 € |
| 3038137 | frame black, cover black (31529)                           | 289.92 € |
| 3038139 | frame black, cover dark grey (31528)                       | 289.92 € |
| 3038133 | frame black, cover cream (31507)                           | 289.92 € |
| 3038148 | frame black, cover toffee (31506) <b>NEW!</b>              | 289.92 € |
| 3038149 | frame black, cover cuoio (31515) <b>NEW!</b>               | 289.92 € |

### Optional accessories

|         |                                               |         |
|---------|-----------------------------------------------|---------|
| 1111139 | Cleaning spray for artificial leather, 500 ml | 14.87 € |
|---------|-----------------------------------------------|---------|



3038310

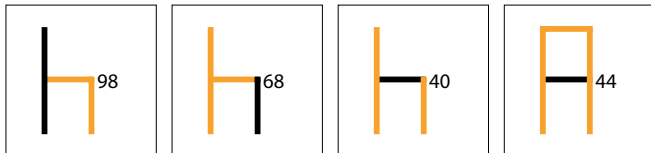

### Buccia 2K



Stool.

- seat and backrest upholstered imitation leather
- abrasion resistance > 100.000
- closed backrest
- max. load ca. 130 kg
- **seat height 68 cm**

**Delivery time 4–5 weeks.**

|                             |                                                            |                 |
|-----------------------------|------------------------------------------------------------|-----------------|
| <b>3038310</b>              | Frame stainless steel, cover light mud (28004)             | <b>298.32 €</b> |
| <b>3038314</b>              | frame stainless steel, cover dark grey (31528) <b>NEW!</b> | <b>298.32 €</b> |
| <b>Optional accessories</b> |                                                            |                 |
| <b>1111139</b>              | Cleaning spray for artificial leather, 500 ml              | <b>14.87 €</b>  |



3038356

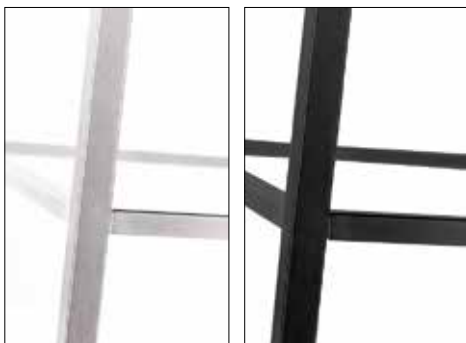
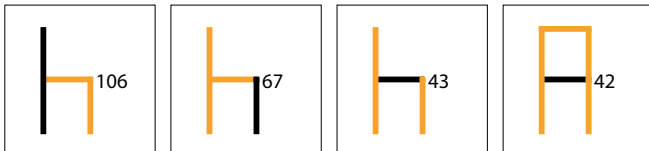

## Borsa 2K



Stool.

- seat and backrest upholstered imitation leather
- abrasion resistance > 100.000
- closed backrest
- max. load ca. 130 kg
- seat height 67 cm

Delivery time 4–5 weeks.

Selected models available from stock.

Current delivery time information on [naber.com](http://naber.com)

|         |                                                            |          |
|---------|------------------------------------------------------------|----------|
| 3038346 | frame stainless steel, cover light mud (28004)             | 290.76 € |
| 3038378 | frame stainless steel, cover dark grey (31528) <b>NEW!</b> | 290.76 € |
| 3038348 | frame black, cover black (31529)                           | 290.76 € |
| 3038351 | frame black, cover dark grey (31528)                       | 290.76 € |
| 3038356 | frame black, cover bordeaux red (31512)                    | 290.76 € |

### Optional accessories

|         |                                               |         |
|---------|-----------------------------------------------|---------|
| 1111139 | Cleaning spray for artificial leather, 500 ml | 14.87 € |
|---------|-----------------------------------------------|---------|



**Barile 2K**



Stool.

- seat and backrest upholstered imitation leather
- abrasion resistance > 100.000
- closed backrest
- max. load ca. 130 kg
- **seat height 67 cm**

**Delivery time 4–5 weeks.**

3038326

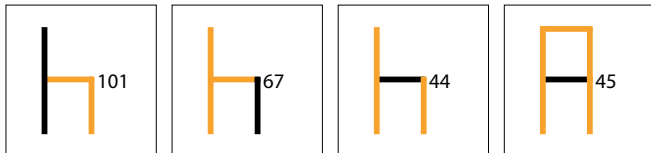

|                                                               |                 |
|---------------------------------------------------------------|-----------------|
| <b>3038325</b> frame stainless steel, cover light mud (28004) | <b>292.44 €</b> |
| <b>3038326</b> frame stainless steel, cover dark grey (31528) | <b>292.52 €</b> |



### Felice 2K

**NEW!**

Stool.

- seat and backrest upholstered imitation leather
- abrasion resistance > 100.000
- closed backrest
- max. load ca. 130 kg
- **seat height 68 cm**

Delivery time 4–5 weeks.

3038333

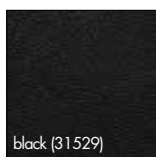
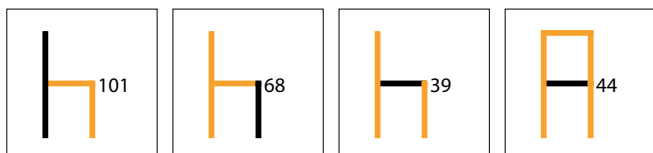

3038333 frame black, cover black (31529)

335.29 €





3038394

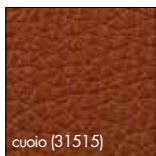
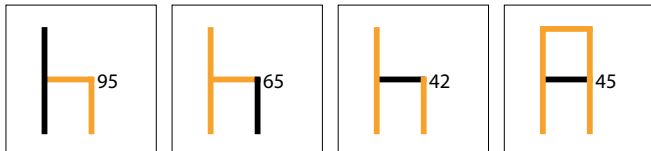

### Lino 2K

Stool.

- seat and backrest upholstered imitation leather
- abrasion resistance > 100.000
- closed backrest
- supports up to approx. 130 kg
- **seat height 65 cm**

**Delivery time 4–5 weeks.**

**Selected models available from stock.**

**Current delivery time information on [naber.com](http://naber.com)**

|                                                              |                 |
|--------------------------------------------------------------|-----------------|
| <b>3038295</b> frame black, cover black (31529)              | <b>260.50 €</b> |
| <b>3038296</b> frame black, cover dark grey (31528)          | <b>260.50 €</b> |
| <b>3038391</b> frame black, cover cream (31507)              | <b>260.50 €</b> |
| <b>3038394</b> frame black, cover toffee (31506) <b>NEW!</b> | <b>260.50 €</b> |
| <b>3038395</b> frame black, cover cuoio (31515) <b>NEW!</b>  | <b>260.50 €</b> |

#### Optional accessories

|                                                              |                |
|--------------------------------------------------------------|----------------|
| <b>1111139</b> Cleaning spray for artificial leather, 500 ml | <b>14.87 €</b> |
|--------------------------------------------------------------|----------------|



3039058

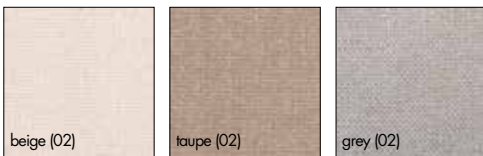
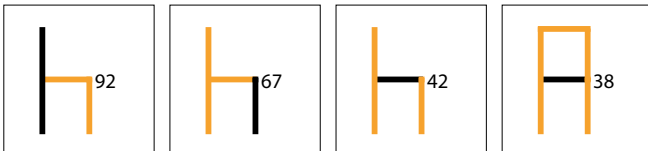

## Eda 2R

**NEW!**

Stool.

- seat and backrest in 100 % recycled polyester
- abrasion resistance 50.000
- water-repellent
- closed backrest
- load-bearing capacity up to approx. 160 kg
- **seat height 67 cm**
- delivered disassembled

**Delivery time 4–5 weeks.**

|                                                  |                 |
|--------------------------------------------------|-----------------|
| <b>3039057</b> frame black, cover beige (02)     | <b>220.17 €</b> |
| <b>3039058</b> frame black, cover taupe (02)     | <b>220.17 €</b> |
| <b>3039059</b> frame black, cover grey (02)      | <b>220.17 €</b> |
| <b>Optional accessories</b>                      |                 |
| <b>3039101</b> Care set for textiles, 2 x 500 ml | <b>57.56 €</b>  |



3038196

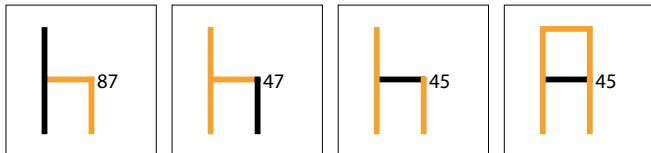

### Daimo 1K



Chair.

- seat and backrest upholstered imitation leather
- abrasion resistance > 100.000
- closed backrest
- max. load ca. 130 kg
- **seat height 47 cm**

**Delivery time 4–5 weeks.**

**Selected models available from stock.**

**Current delivery time information on [naber.com](http://naber.com)**

|                                                                           |                 |
|---------------------------------------------------------------------------|-----------------|
| <b>3038191</b> frame stainless steel, cover black (31529)                 | <b>251.26 €</b> |
| <b>3038192</b> frame stainless steel, cover light mud (28004)             | <b>251.26 €</b> |
| <b>3038193</b> frame stainless steel, cover dark anthracite (28005)       | <b>251.26 €</b> |
| <b>3038198</b> frame stainless steel, cover dark grey (31528) <b>NEW!</b> | <b>251.26 €</b> |
| <b>3038194</b> frame black, cover black (31529)                           | <b>251.26 €</b> |
| <b>3038197</b> frame black, cover dark grey (31528)                       | <b>251.26 €</b> |
| <b>3038196</b> frame black, cover cream (31507)                           | <b>251.26 €</b> |
| <b>3038199</b> frame black, cover toffee (31506) <b>NEW!</b>              | <b>251.26 €</b> |
| <b>3038200</b> frame black, cover cuoio (31515) <b>NEW!</b>               | <b>251.26 €</b> |

#### Optional accessories

|                                                              |                |
|--------------------------------------------------------------|----------------|
| <b>1111139</b> Cleaning spray for artificial leather, 500 ml | <b>14.87 €</b> |
|--------------------------------------------------------------|----------------|



### Buccia 1K



Chair.

- seat and backrest upholstered imitation leather
- abrasion resistance > 100.000
- closed backrest
- max. load ca. 130 kg
- **seat height 48 cm**

**Delivery time 4–5 weeks.**

3038313

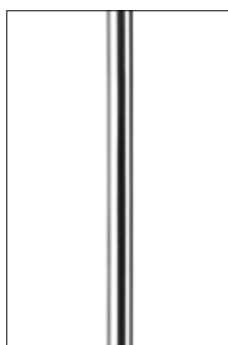
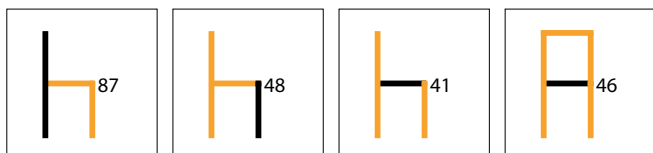

|                                                                           |                 |
|---------------------------------------------------------------------------|-----------------|
| <b>3038312</b> frame stainless steel, cover light mud (28004)             | <b>268.91 €</b> |
| <b>3038313</b> frame stainless steel, cover dark grey (31528) <b>NEW!</b> | <b>268.91 €</b> |
| <b>Optional accessories</b>                                               |                 |
| <b>1111139</b> Cleaning spray for artificial leather, 500 ml              | <b>14.87 €</b>  |



3038363

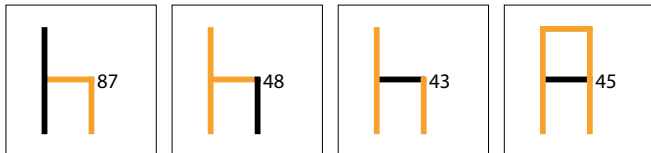

**Borsa 1K**



Chair.

- seat and backrest upholstered imitation leather
- abrasion resistance > 100.000
- closed backrest
- max. load ca. 130 kg
- **seat height 48 cm**

**Delivery time 4–5 weeks.**

|                                                                           |                 |
|---------------------------------------------------------------------------|-----------------|
| <b>3038358</b> frame stainless steel, cover light mud (28004)             | <b>250.42 €</b> |
| <b>3038377</b> frame stainless steel, cover dark grey (31528) <b>NEW!</b> | <b>250.42 €</b> |
| <b>3038360</b> frame black, cover black (31529)                           | <b>250.42 €</b> |
| <b>3038363</b> frame black, cover dark grey (31528)                       | <b>250.42 €</b> |
| <b>Optional accessories</b>                                               |                 |
| <b>1111139</b> Cleaning spray for artificial leather, 500 ml              | <b>14.87 €</b>  |



**Barile 1K**

**NEW!**

- Chair.
- seat and backrest upholstered imitation leather
  - abrasion resistance > 100.000
  - closed backrest
  - max. load ca. 130 kg
  - **seat height 47 cm**

**Delivery time 4–5 weeks.**

3038319

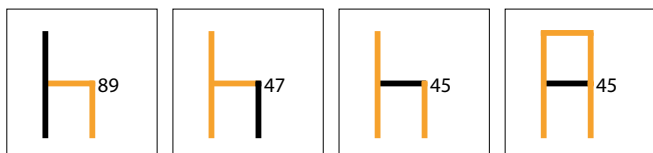

|                                                               |                 |
|---------------------------------------------------------------|-----------------|
| <b>3038319</b> frame stainless steel, cover light mud (28004) | <b>247.06 €</b> |
| <b>3038320</b> frame stainless steel, cover dark grey (31528) | <b>247.06 €</b> |



3038291

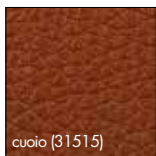
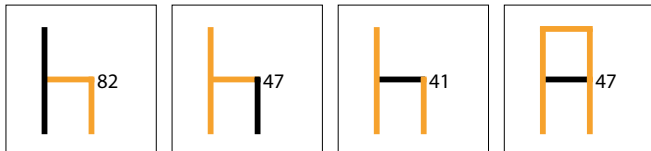

### Lino 1K

Chair.

- seat and backrest upholstered imitation leather
- abrasion resistance > 100.000
- closed backrest
- supports up to approx. 130 kg
- **seat height 47 cm**

**Delivery time 4–5 weeks.**

|                                                              |                 |
|--------------------------------------------------------------|-----------------|
| <b>3038291</b> frame black, cover black (31529)              | <b>254.62 €</b> |
| <b>3038292</b> frame black, cover dark grey (31528)          | <b>254.62 €</b> |
| <b>3038390</b> frame black, cover cream (31507)              | <b>254.62 €</b> |
| <b>3038392</b> frame black, cover toffee (31506) <b>NEW!</b> | <b>254.62 €</b> |
| <b>3038393</b> frame black, cover cuoio (31515) <b>NEW!</b>  | <b>254.62 €</b> |

#### Optional accessories

|                                                              |                |
|--------------------------------------------------------------|----------------|
| <b>1111139</b> Cleaning spray for artificial leather, 500 ml | <b>14.87 €</b> |
|--------------------------------------------------------------|----------------|



3039051

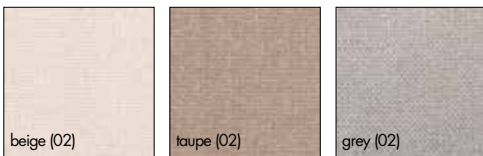
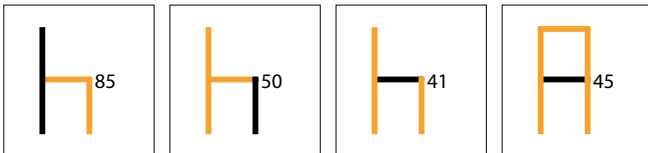

## Kyra 1R

**NEW!**

Chair.

- seat and backrest in 100 % recycled polyester
- abrasion resistance 50.000
- water-repellent
- closed backrest
- load-bearing capacity up to approx. 160 kg
- **seat height 50 cm**
- delivered disassembled

**Delivery time 4–5 weeks.**

|                                                  |                 |
|--------------------------------------------------|-----------------|
| <b>3039049</b> frame black, cover beige (02)     | <b>233.61 €</b> |
| <b>3039050</b> frame black, cover taupe (02)     | <b>233.61 €</b> |
| <b>3039051</b> frame black, cover grey (02)      | <b>233.61 €</b> |
| <b>Optional accessories</b>                      |                 |
| <b>3039101</b> Care set for textiles, 2 x 500 ml | <b>57.56 €</b>  |





3039046

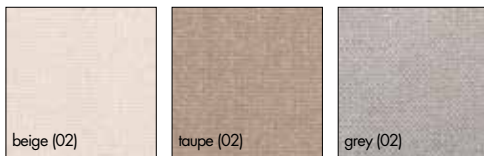
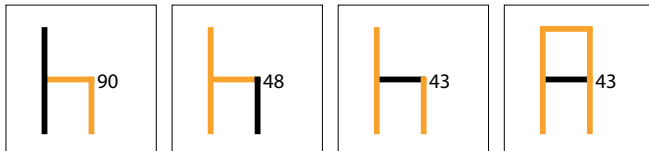

**Cara 1R**

**NEW!**

Chair.

- seat and backrest in 100 % recycled polyester
- abrasion resistance 50.000
- water-repellent
- closed backrest
- load-bearing capacity up to approx. 160 kg
- height to top edge of armrests 71 cm
- width incl. armrests 56 cm
- **seat height 48 cm**
- delivered disassembled

**Delivery time 4-5 weeks.**

|                                                  |                 |
|--------------------------------------------------|-----------------|
| <b>3039046</b> frame black, cover beige (02)     | <b>284.87 €</b> |
| <b>3039047</b> frame black, cover taupe (02)     | <b>284.87 €</b> |
| <b>3039048</b> frame black, cover grey (02)      | <b>284.87 €</b> |
| <b>Optional accessories</b>                      |                 |
| <b>3039101</b> Care set for textiles, 2 x 500 ml | <b>57.56 €</b>  |



3039042

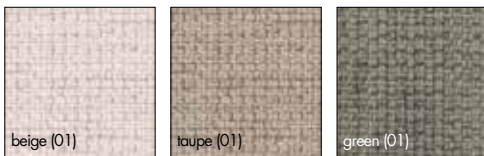
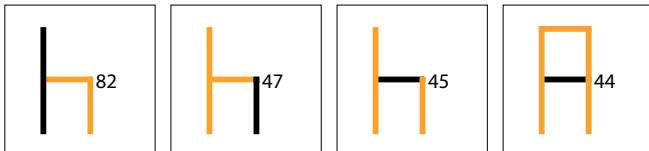

## Maya 1R

**NEW!**

Chair.

- seat and backrest in 100 % recycled polyester
- abrasion resistance 50.000
- water-repellent
- closed backrest
- load-bearing capacity up to approx. 160 kg
- height to top edge of armrests 65 cm
- width incl. armrests 60 cm
- **seat height 47 cm**
- delivered disassembled

**Delivery time 4–5 weeks.**

|                                                  |                 |
|--------------------------------------------------|-----------------|
| <b>3039040</b> frame black, cover beige (01)     | <b>342.02 €</b> |
| <b>3039041</b> frame black, cover taupe (01)     | <b>342.02 €</b> |
| <b>3039042</b> frame black, cover green (01)     | <b>342.02 €</b> |
| <b>Optional accessories</b>                      |                 |
| <b>3039101</b> Care set for textiles, 2 x 500 ml | <b>57.56 €</b>  |



3039044

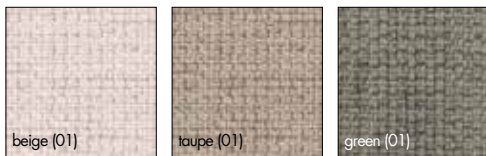
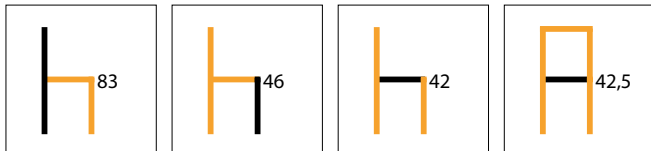

**Aiden 1R** **NEW!**

- Chair.
- seat and backrest in 100 % recycled polyester
  - abrasion resistance 50.000
  - water-repellent
  - open backrest
  - load-bearing capacity up to approx. 160 kg
  - **seat height 46 cm**
  - delivered disassembled

**Delivery time 4–5 weeks.**

|                                                  |                 |
|--------------------------------------------------|-----------------|
| <b>3039043</b> frame black, cover beige (01)     | <b>197.48 €</b> |
| <b>3039044</b> frame black, cover taupe (01)     | <b>197.48 €</b> |
| <b>3039045</b> frame black, cover green (01)     | <b>197.48 €</b> |
| <b>Optional accessories</b>                      |                 |
| <b>3039101</b> Care set for textiles, 2 x 500 ml | <b>57.56 €</b>  |



3039054

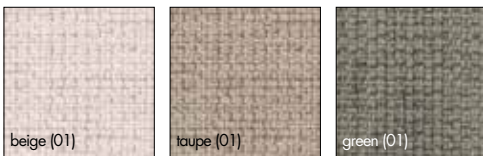
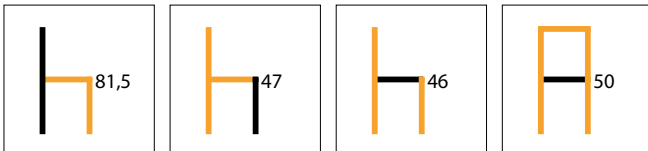

### Rocco 1R

**NEW!**

Chair.

- seat and backrest in 100 % recycled polyester
- abrasion resistance 50.000
- water-repellent
- open backrest
- load-bearing capacity up to approx. 160 kg
- **seat height 47 cm**
- delivered disassembled

**Delivery time 4-5 weeks.**

|                                                  |                 |
|--------------------------------------------------|-----------------|
| <b>3039052</b> frame black, cover beige (01)     | <b>223.53 €</b> |
| <b>3039053</b> frame black, cover taupe (01)     | <b>223.53 €</b> |
| <b>3039054</b> frame black, cover green (01)     | <b>223.53 €</b> |
| <b>Optional accessories</b>                      |                 |
| <b>3039101</b> Care set for textiles, 2 x 500 ml | <b>57.56 €</b>  |

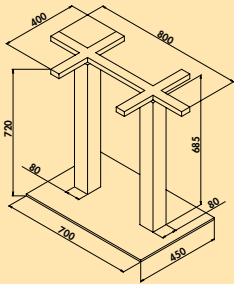

### Livia E Duo stainless-steel

**NEW!**

Table frame, square.

- pipe 80 x 80 mm
- base plate 700 x 450 mm
- incl. adjustable feet to compensate for uneven floors
- upper mounting cross 800 x 400 mm
- for table top max. 1400 x 800 mm (not included in the scope of delivery)
- **H 720 mm**
- supports up to approx. 70 kg
- cannot be shortened
- not suitable for granite tops
- assembly required

**3036417** stainless-steel

**359.67 €**

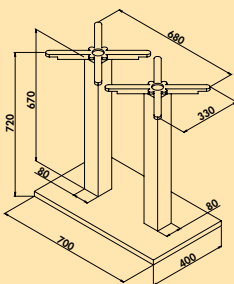

### Livia E Duo black matt

**NEW!**

Table frame, square.

- pipe 80 x 80 mm
- upper mounting plate 700 x 400 mm
- incl. adjustable feet to compensate for uneven floors
- upper attachment crosses 680 x 330 mm
- for table top max. 1400 x 800 mm (not included in the scope of delivery)
- **H 720 mm**
- supports up to approx. 70 kg
- cannot be shortened
- not suitable for granite tops
- assembly required

**3036418** black matt

**252.10 €**

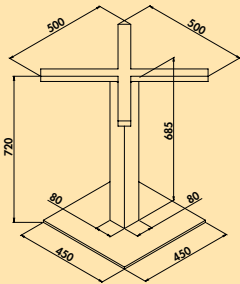

### Livia E stainless steel

**NEW!**

- Table frame, square.
- pipe 80 x 80 mm
  - base plate 450 x 450 mm
  - incl. adjustable feet to compensate for uneven floors
  - mounting cross 500 x 500 mm
  - for table top max. 800 x 800 mm (not included in the scope of delivery)
  - **H 720 mm**
  - supports up to approx. 50 kg
  - cannot be shortened
  - not suitable for granite tops
  - assembly required

3036419 stainless steel

234.45 €

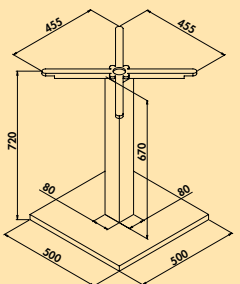

### Livia E black matt

**NEW!**

- Table frame, square.
- pipe 80 x 80 mm
  - base plate 500 x 500 mm
  - incl. adjustable feet to compensate for uneven floors
  - mounting cross 455 x 455 mm
  - for table top max. 900 x 900 mm (not included in the scope of delivery)
  - **H 720 mm**
  - supports up to approx. 50 kg
  - cannot be shortened
  - not suitable for granite tops
  - assembly required

3036420 black matt

216.80 €

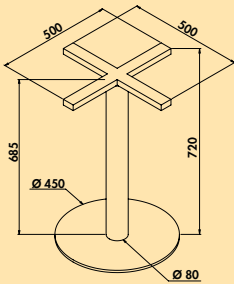

### Livia R stainless steel

**NEW!** 

Table frame, round.

- pipe Ø 80 mm
- base plate Ø 450 mm
- incl. adjustable feet to compensate for uneven floors
- mounting cross 500 x 500 mm
- for table top max. Ø 800 mm (not included in the scope of delivery)
- **H 720 mm**
- supports up to approx. 40 kg
- cannot be shortened
- not suitable for granite tops
- assembly required

**3036421** stainless steel

**215.13 €**

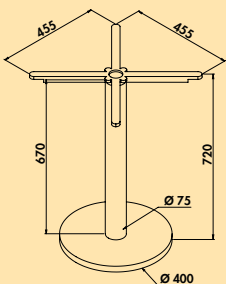

### Livia R black matt

**NEW!**

Table frame, square.

- pipe Ø 75 mm
- base plate Ø 400 mm
- incl. adjustable feet to compensate for uneven floors
- mounting cross 455 x 455 mm
- for table top max. Ø 800 mm (not included in the scope of delivery)
- **H 720 mm**
- supports up to approx. 40 kg
- cannot be shortened
- not suitable for granite tops
- assembly required

**3036422** black matt

**136.14 €**

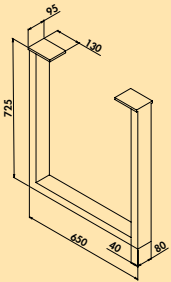

### Thalea U

**NEW!**

U-Table frame.

- pipe 40 x 80 mm
- incl. adjustable feet to compensate for uneven floors (plus 15 mm height adjustment)
- for table top max. 2600 x 1000 mm (not included in the scope of delivery)
- upper mounting plates 130 x 95 mm
- W 650 x H 725 mm
- supports up to approx. 150 kg/pair
- not suitable for granite tops
- **1 PU = 1 pair**

3036423 black matt, price per PU

323.53 €

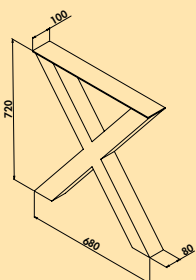

### Xtreme

**NEW!**

X-Table frame.

- pipe 80 x 80 mm
- incl. adjustable feet to compensate for uneven floors (plus 10 mm height adjustment)
- for table top max. 2600 x 1000 mm (not included in the scope of delivery)
- upper mounting plate 680 x 100 mm
- W 680 x H 720 mm
- supports up to approx. 150 kg/pair
- not suitable for granite tops
- **1 PU = 1 pair**

3036424 black matt, price per PU

323.53 €





# General Terms of Sale B2B

Version 01/2023

## I. Scope of application

1. The following Terms of Sale shall apply for all contracts concluded between the purchaser and us concerning the delivery of goods if the purchaser is a company (§ 14 German Civil Code [Bürgerlichesgesetzbuch, BGB]). These Terms also apply for all future contracts concerning the delivery of goods even if they are not expressly mentioned again. Conflicting terms of the purchaser that we do not expressly recognize are not binding for us even if we do not expressly contradict such terms. The following Terms of Sale shall also then apply if we carry out the purchaser's order without reservation and with knowledge of the contradictory or differing terms of the purchaser.
2. All agreements that were entered into between the purchaser and us for performing the purchase contracts are documented in writing in the contracts. The parties shall confirm all oral agreements in writing. If contracts are set out in both the German and also a foreign language, in the case of a dispute, the German language version is determinative.

## II. Offer and contract conclusion

1. We can accept a purchaser's order that is to be qualified as an offer to conclude a purchase contract within two weeks—for an order in the Naber dealer portal, 5 working days—by transmitting an order confirmation or by sending ordered products within the same time limit. The purchaser is bound to the purchaser's order for this time period.
2. Our offers are subject to change and nonbinding unless we have expressly identified them as binding.
3. All oral and written information concerning possible applications and the suitability of all goods are carried out to the best of our knowledge. However, this information only represents our historical experience, which cannot be deemed to be consistently warranted. This information does not form the basis for any claims against us. In particular, the purchaser is not relieved of the duty of ensuring by means of the purchaser's own inspection that the goods are suitable for the purchaser's intended use.
4. We reserve all rights of ownership, copyright and other industrial property rights in images, calculations, drawings, sample books, catalogs and other documents. The purchaser may only transfer these to a third-party with our prior written consent irrespective of whether we have designated these items to be confidential.

## III. Payment terms

1. All prices apply ex works without packaging and must be paid in Euros if not otherwise set out in our order confirmation. The statutory value added tax is not included in our prices. This will be separately disclosed in the invoice at the statutory amount on the date of invoicing.
2. The purchase price is due 10 days after the invoice is sent (invoice date) less a 2% discount, otherwise net (without discount) 30 days after the invoice date provided that no different payment target follows from the order confirmation. A payment is not deemed to have taken place until the funds are available for our use. In the event of payments by check, the payment is not deemed to have taken place until the check is cashed. For new customers we reserve the right to deliver against cash on delivery less a 2% discount. For orders with a value of goods up to € 50.00 net, we reserve a minimum quantity surcharge of € 6.50. In the case of a contract included with an agreement of „advance payment“, the purchase price is due 10 days after the invoice date.
3. If the purchaser is in default in making payment, the statutory provisions shall apply (§ 288 BGB).
4. The purchaser is only entitled to set-off, even if a notice of defects or counterclaims are asserted, if the counterclaims have been conclusively adjudicated or are undisputed. The purchaser is only authorized to exercise a right of retention if the counterclaim is based on the same contractual relationship.
5. We reserve the right to request payment security and/or advance payments.
6. If the purchaser is in default of payment or if there is reasonable doubt concerning purchaser's ability to pay, we are entitled to declare all claims against purchaser as due for payment and/or to retain as yet outstanding deliveries in their entirety or in part or to withdraw from the existing contracts entirely.

## IV. Delivery and performance times, liability for delivery delays

1. Delivery dates or time limits that have not been expressly agreed to be binding are solely non-binding declarations. The delivery time stated by us shall not commence prior to complete clarification of the order and clarification of all technical questions. The purchaser must likewise properly and timely fulfill all obligations incumbent upon purchaser.
2. Force majeure cases, e.g. labor disputes, civil unrest as well as other unforeseeable damaging events for which we are not responsible, extend the delivery time period for the duration of the disruption insofar as the disruption demonstrably influences our ability to render the service. This also applies if these circumstances occur for our suppliers. If the disruption lasts for longer than four weeks subsequent to the expiration of the originally agreed scheduled date, each contracting party can withdraw from the contract. The withdrawal extends to the part of the contract not yet fulfilled, unless the partial performance to be provided is not usable by purchaser. No compensatory damage

claims accrue to the purchaser from this situation.

3. If the underlying purchase contract involves a transaction for delivery by a fixed date within the meaning of the BGB or the Commercial Code (Handelsgesetzbuch, HGB), we are liable according to the statutory provisions. The same applies if the purchaser is entitled, as a consequence of a delayed delivery for which we are responsible, to assert the discontinuation of his interest in the further fulfillment of the contract. In this case our liability is limited to the foreseeable, typically occurring damages if the delayed delivery is not based on an intentional violation of the contract for which we are responsible. We shall likewise be liable to the purchaser for delayed delivery according to the statutory provisions if this delay is based on an intentional or grossly negligent violation of the contract for which we are responsible. Our liability is limited to the foreseeable, typically occurring damages if the delayed delivery is not based on an intentional violation of the contract for which we are responsible. In any case the occurrence of a delay requires a reminder notice from purchaser.
4. Otherwise, in the event of a delivery delay for which we are responsible, purchaser can request a flat amount of compensation in the amount of 0.5 % of the value of goods to be delivered, however a maximum of no more than 5 % of the value of goods to be delivered.
5. Any further liability for a delivery delay for which we are responsible is precluded.
6. We are at all times entitled to make partial deliveries and carry out partial performance insofar as this is reasonable for the customer.
7. In the case of an agreement for „advance payment“, we are not obligated to make the delivery until the funds invoiced are available for our use.

## V. Transfer of risk, delay in acceptance, shipping/packaging

1. Loading and shipping are at the purchaser's risk. The regulations concerning a sale by delivery to a place other than the place of performance according to § 447 BGB shall apply even if the shipment is undertaken with our means of transport or by our employees.
2. We shall make every effort to take into consideration the wishes and interests of the purchaser with respect to the type of shipment and route; additional expenditures thereby required—also in the case of an agreed freight paid delivery—shall be at the purchaser's expense. A transportation insurance policy shall be concluded for the shipment if the purchaser expressly requests this with the order. The costs shall be billed to the purchaser and separately set out in the invoice.
3. We will not take back transportation packaging and all other packaging according to the packaging regulation; excepted from this are pallets. Purchaser must ensure the disposal of the packaging at its own expense.
4. If the shipment is delayed at the purchaser's request or due to the purchaser's fault, we will then store the goods at the expense and risk of purchaser. In this case a notice of readiness to dispatch is equivalent to shipment.
5. If the purchaser delays acceptance, we are then entitled to request compensation for the resulting damages and any additional expenditures. The same applies if the purchaser culpably violates duties of cooperation. With the occurrence of a delay in acceptance or the delayed payment of a debt on the part of the purchaser, the risk of accidental deterioration and loss of the goods passes to the purchaser.
6. We shall not assume any costs for returns that are not agreed with us in advance in writing or returns that are not expressly recognized as legitimate after evaluation of the reason for the return (e.g. incorrect delivery, defects, etc.). Should we incur costs for returns that are not agreed or not legitimate, we shall bill the purchaser/sender in the amount of the actually incurred third-party costs as well as our own costs.

## VI. Warranty/liability

1. We do not assume any warranty for defects that arise due to natural wear and tear, faulty or negligent treatment, improper storage, inappropriate or improper use or nonobservance of the processing and use instructions. If the delivery takes place according to drawings, specifications, samples, etc. of purchaser, the purchaser assumes the risk of their suitability for the intended use.
2. The purchaser's claims for defects shall only exist if purchaser has properly complied with purchaser's duties of inspection and providing notice of defects. Therefore, purchaser is obligated to promptly provide notice of apparent defects in the goods upon receipt. In the case of hidden defects that purchaser cannot ascertain upon receipt of the goods, purchaser must promptly give notice of defects subsequent to their discovery.
3. In the case of a complaint, we are entitled at our option to request that purchaser send us the rejected goods for inspection or for subsequent performance or make the rejected goods available to us. We shall only bear the costs of this shipment in the case of a legitimate complaint.
4. In the case of a defect we are entitled to carry out the subsequent performance of our choice by means of a replacement delivery or by repairing the defective goods within a reasonable grace period. There is no duty of subsequent performance insofar as we are authorized to refuse subsequent performance on the basis of statutory provisions. In our selection of the type of subsequent performance, we must take into consideration the type of defect and the legitimate interests of

the purchaser. We shall bear the expenses necessary for the purpose of subsequent performance. We shall not bear the additional cost that arises thereby that the goods have been transported to a different location than the place of performance or the registered commercial offices of the ordering party unless this transport is in conformity with the intended use of the goods.

5. If the subsequent performance fails, purchaser can elect a decrease in the purchase price (reduction) or declare purchaser's withdrawal from the contract. If the purchaser withdraws from the contract, purchaser is not entitled to an additional claim for compensation for damages unless we are responsible for the defect due to intentional acts or gross negligence. If only part of the delivery of goods is defective, purchaser can only then withdraw from the entire contract if purchaser does not have any interest in the remaining part of the delivery.
6. Purchaser's claim for recourse by virtue of warranty claims and rights arising from consumer goods purchase contracts (§§ 474, 478 BGB), may only be asserted against us by purchaser to the extent that purchaser is obligated to satisfy warranty claims and rights towards purchaser's customers on the basis of statutory provisions. The claim for recourse against us is excluded to the extent that purchaser has a warranty or liability obligation towards purchaser's customers in the absence of a legal obligation, in particular, as a gesture of goodwill or on the basis of special assurances or guarantees of the purchaser.
7. The claims and rights owing to a defect in the goods may only be asserted by purchaser within the warranty period of twelve months after delivery of the goods. This does not apply for claims and rights for which longer notice periods are mandatorily prescribed according to § 438 paragraph 1 No. 2 BGB for construction, and objects for construction (construction materials) or according to § 445b BGB for the recourse claims of a company.
8. We are liable according to statutory provisions for damages to life, the body and health that are based on a negligent or intentional violation of duties by us or our legal representatives or our vicarious agents as well as for damages that are encompassed by liability under the Product Liability Act. We are liable according to statutory provisions for damages that are not comprehended by sentence 1 and that are based on intentional or grossly negligent contract violations as well as deceit by us, our legal representative or our vicarious agents. However, in this case the liability for compensatory damages is limited to foreseeable, typically occurring damages insofar as we, our legal representative or our vicarious agents did not act intentionally. To the extent that we have provided a guarantee of quality and/or durability with reference to the goods or parts thereof, we shall also be liable within the framework of this guarantee. However, for damages that are based on a lack of quality or durability as guaranteed, but that do not occur directly with regard to the goods, we are only then liable if the risk of such damages is obviously comprehended by the guarantee of quality and durability.
9. We are also liable for damages that are caused by simple negligence insofar as the negligence is related to the violation of those contractual obligations the observance of which are of particular importance for achieving the purpose of the contract (material obligations). In this case, however, our liability is restricted to typically foreseeable damages.
10. Any further liability is excluded without considering the legal nature of the claim asserted; this also applies in particular for tort claims, for claims for reimbursement of futile expenditures in place of performance, or for compensation claims for lost profits. Insofar as our liability is excluded or limited, this shall also apply for the personal liability of our personnel, employees, staff, representatives and vicarious agents.
11. Purchaser's compensatory damage claims on account of a defect are time-barred one year after delivery of the goods. This shall not apply in the case of injuries to life, the body, or health for which we, our legal representatives or our vicarious agents are at fault or if we or our legal representatives have acted in an intentional or grossly negligent manner, or if our ordinary vicarious agents have acted intentionally.
12. Our sales representatives and commercial agents are not authorized to make legally binding statements with regard to defects and warranty claims for us.

#### **VII. Retention of Title**

1. a) The delivered goods (goods subject to retention of title) remain our property (extended retention of title) until all claims are satisfied against the purchaser, including all outstanding balance claims from a current account to which we are entitled arising from the order and the entire business relationship.
1. b) To the extent that an extended retention of title is not applicable in the country in which the purchaser has its registered office, the delivered goods remain our property (ordinary retention of title) until all claims to which we are entitled against the purchaser from the respective order have been satisfied, including taxes, charges or transportation costs.
2. In the case of purchaser's conduct contrary to the contract, e.g. delayed payment, we are entitled to take back the goods subject to retention of title after setting a reasonable time limit in advance; if it is unnecessary to set a time limit according to the provisions of the law, we are also entitled to demand the return of the goods subject to a retention of title without a grace period. If we take back the goods subject to a retention of title, this represents a withdrawal from the contract. If we levy execution against the goods subject to a retention of title, this is a withdrawal from the contract. We are entitled to realize on the sale of the goods subject to a retention of title subsequent to taking them back. After deducting a reasonable amount for the cost of realizing the sale, the proceeds from the sale shall be settled against the amounts owed to us by purchaser.
3. Purchaser shall treat the goods subject to a retention of title with care and sufficiently insure these

goods at their original value against losses due to fire, water damage and theft. Maintenance and inspection work that become necessary must be timely carried out by purchaser at purchaser's expense.

4. The purchaser is authorized to sell and/or use the goods subject to a retention of title in the ordinary course of business as long as purchaser is not in default in payment. Pledging and transfers by way of security are impermissible. Claims arising from resale of the processed or unprocessed goods subject to a retention of title, or arising for another legal reason (insurance, unlawful acts) with respect to the goods subject to a retention of title (including all outstanding balance claims from a current account) are already transferred by purchaser to us as security in the amount of the final invoice amount (including VAT) for our claims against the purchaser; we hereby accept the assignment. We revocably authorize purchaser to collect the claims assigned to us in the name of purchaser and for purchaser's account. This collection authorization can be revoked at any time if purchaser does not properly comply with purchaser's payment obligations.
5. For the purpose of assigning this claim, purchaser is also not authorized to collect claims by way of factoring unless an obligation of the factoring party is at the same time created to directly effectuate payment of consideration to us in the amount of the claims for as long as our claims against the purchaser exist.
6. Processing or reshaping the goods subject to a retention of title by purchaser shall in any case be undertaken for us. If the goods subject to a retention of title are processed with other items not owned by us, we shall acquire joint ownership in the new item proportional to the value of the goods subject to a retention of title (final invoice amount including value added tax) along with the other processed items on the date of processing. The same shall apply for the new item emerging from the processing as for the goods subject to a retention of title. In the case of the inseparable combination of the goods subject to a retention of title with other items not owned by us, we shall acquire joint ownership in the new item proportional to the value of the goods subject to a retention of title (final invoice amount including value added tax) along with the other combined items on the date on which they are combined. If the purchaser's item is to be viewed as the primary item as a consequence of this combining, the purchaser and we agree that purchaser transfers proportional joint ownership to us in the item; we hereby accept this transfer. Purchaser shall preserve the sole or joint ownership in the item arising in this manner for us.
7. In the event of attachment by third parties against the goods subject to a retention of title, in particular, levies of execution, purchaser shall call attention to our ownership and immediately inform us so that we may enforce our rights of ownership. To the extent that the third-party is not in the position to reimburse us for the court and out-of-court expenses arising in this connection, purchaser is liable therefor.
8. We are obligated to release the security to which we are entitled to the extent that the realizable value of our security exceeds the claims to be secured by more than 10%; in so doing, the selection of the security to be released is at our discretion.

#### **VIII. Images and dimensions**

Images, technical information and dimensions in brochures and price lists shall not be deemed to be a binding agreement and not a promised characteristic. These only represent approximate values. Binding information can be provided in an individual case upon request. Special suitability may not be taken from the images and dimensions. We expressly reserve the right to make modifications.

#### **IX. Place of performance, venue, applicable law**

1. The place of performance for deliveries and payments (including actions regarding checks and bills of exchange), is, if not otherwise expressly specified, our registered office in Nordhorn.
2. The exclusive local jurisdiction and international court of competent jurisdiction is in the location of our registered office in Nordhorn (Germany). However, we are also authorized to sue the purchaser in purchaser's place of general jurisdiction (domicile or registered office).
3. The business relations between the contracting parties are regulated exclusively according to the law applicable in the Federal Republic of Germany excluding international private law (Introductory Statute to the Civil Code [Einführungsgesetz zum Bürgerlichen Gesetzbuch], EGBGB). The application of the UN Convention on Contracts for the International Sale of Goods is excluded.
4. Should a provision of these general Terms of Sale (or within the framework of other agreements) be or become invalid or unenforceable entirely or in part, this shall not affect the validity of all other provisions or agreements. The contracting parties hereby commit to replace the invalid or unenforceable provision or agreement with a valid or enforceable provision or agreement most closely in conformity with the commercial provisions.
5. The headings for the individual regulations of these delivery and payment terms only serve to provide a better orientation and do not have any independent substantive content and no legal significance.
6. The purchaser's data related to the business transactions with purchaser shall be processed according to the Federal Data Protection Act.

#### **X. Precedence of the German version**

If these Terms of Sale exist in different languages, the German version is solely decisive for clarifying questions of interpretation.

Naber GmbH  
Managing Directors: Ingrid Naber, Hans-Joachim Naber and Lasse Naber



Aron R



Rocco 1R



Barile 2K



Eda 2R



Rocco R



Lino 2K



Felice 2K



Cara 1R



Maya 1R



Aiden 1R



Kyra 1R



Barile 1K

Naber GmbH  
Development · Production · Sales

Enschedeestr. 24  
48529 Nordhorn  
Germany  
Tel. +49 5921 704-0  
Fax +49 5921 704-140

naber@naber.com  
www.naber.com

September 2023 EN

**Naber**<sup>®</sup>  
... inspires!